

CHALCOTS ESTATE  
TECHNICAL WINDOW DESIGN  
INFORMATION BOOKLET

# CONTENTS

<b>● 01 NEW WINDOWS</b>	<b>3</b>	<b>● 05 PURGE VENTILATION</b>	<b>23</b>	<b>● 09 RADIATORS</b>	<b>47</b>
Design criteria for the new windows.....	4	How is the purge ventilation calculated?.....	24	What are the options for the new radiators?.....	48
Initial comparison of window types.....	5	Do the new windows meet current purge ventilation standards?.....	25	Trench Heater FAQs.....	49
Analysis outcome.....	6	Trickle vents.....	26	Can I have the trench heater on at night when the curtains are closed?	
Bedroom illustration (example).....	7	<b>● 06 OVERHEATING</b>	<b>27</b>	Are the trench heaters noisy?	
Lounge illustration (example).....	8	How have the overheating & energy conservation improvements been achieved?.....	28	Is it easy to maintain the trench heater?	
Kitchen illustration (example).....	9	Key considerations for overheating calculations.....	29	What if I drop something in the trench heater?	
Bathroom illustration (example).....	10	Why we used the CIBSE TM59 method to calculate overheating.....	30	What if someone leaves paper on the trench heater?	
<b>● 02 WINDOW OPERATION</b>	<b>11</b>	Why use TM59?		Can the heater be turned to face inwards?	
Typical window dimensions.....	12	Is TM59 a future proof method?		Will there be space for plants or storage on my window sill?	
Lounge / bedroom opening positions.....	13	What about climate change?		Is there a risk of a child burning their feet by standing on the grille?	
Kitchen / bathroom opening positions.....	14	The assessment criteria.....	31	Are trench heaters expensive to run?	
<b>● 03 REGULATIONS OVERVIEW</b>	<b>15</b>	Is the analysis carried out on a virtual model?.....	32	Will the trench heaters work with the existing radiators?	
What regulations do the new windows have to meet?.....	16	Are the window reveals taken into account?.....	33	Are there examples of trench heaters used in residential settings?	
<b>● 04 SAFETY</b>	<b>17</b>	Overheating results: Criterion A / 2011 - 2040.....	34	Can the window sill slope downwards into the room to prevent damage from standing on the sill?	
Existing window dimensions.....	18	Overheating results: Criterion A / 2041 - 2070.....	35	<b>● 10 ITEMS RELATED TO THE NEW WINDOWS</b>	<b>54</b>
Why do the existing windows need replacing?.....	19	Overheating results: Criterion B / 2011 - 2040.....	36	How did we decide to make the new panel glazed?.....	55
Why do we have to replace the windows?		Overheating results: Criterion B / 2041 - 2070.....	37	Opaque vs glazed panel overheating results: Criterion A 2011 - 2040 ..	56
What standards do the new windows need to meet?		Advice on how to keep your flat cool in hot weather.....	38	Opaque vs glazed panel overheating results: Criterion A 2041 - 2070 ..	57
The window design process:		<b>● 07 ADDITIONAL CONSIDERATIONS</b>	<b>39</b>	Opaque vs glazed panel overheating results: Criterion B 2011 - 2040 ..	58
Why are the new window sills lowered in lounges and bedrooms?.....	20	Accessible window operation.....	40	Opaque vs glazed panel overheating results: Criterion B 2041 - 2070 ..	59
Risk of fall: guarding heights.....	21	Vertigo / covering the glazed panels.....	41	Will rain come through open windows?.....	60
Why can't the new windows open outwards?.....	22	Ventilation & views into bathrooms.....	42	The aluminium reveals proposal.....	61
		<b>● 08 CURTAINS &amp; BLINDS</b>	<b>43</b>	Condensation.....	62
		Blinds on the windows.....	44	Window sills.....	63
		Curtain inside window reveal.....	45	Fire stopping & cavity barriers:	
		Curtains wall-mounted.....	46	Stopping the spread of fire, smoke & noise	
		<b>● 11 FURTHER QUESTIONS &amp; ANSWERS</b>	<b>64</b>		

**KEY:**

- The coloured dots correspond with the colour on the title page of each chapter, and can be used for ease of reference.
- Residents' questions are highlighted in yellow.



# INITIAL DESIGN DEVELOPMENT

## DESIGN CRITERIA FOR THE NEW WINDOWS

Options for the opening part of the window have been assessed against the criteria shown in the diagram to the right.

These priorities were established based on Camden's June 2018 residents survey about window type options and what residents wanted the windows to achieve.

142 feedback forms were received out of a total of 716 households.

The shaded yellow area graphically illustrates the residents priorities for the window performance.

The top 4 priorities were identified as the following:

- ventilation
- overheating
- weather & acoustic performance
- resident safety

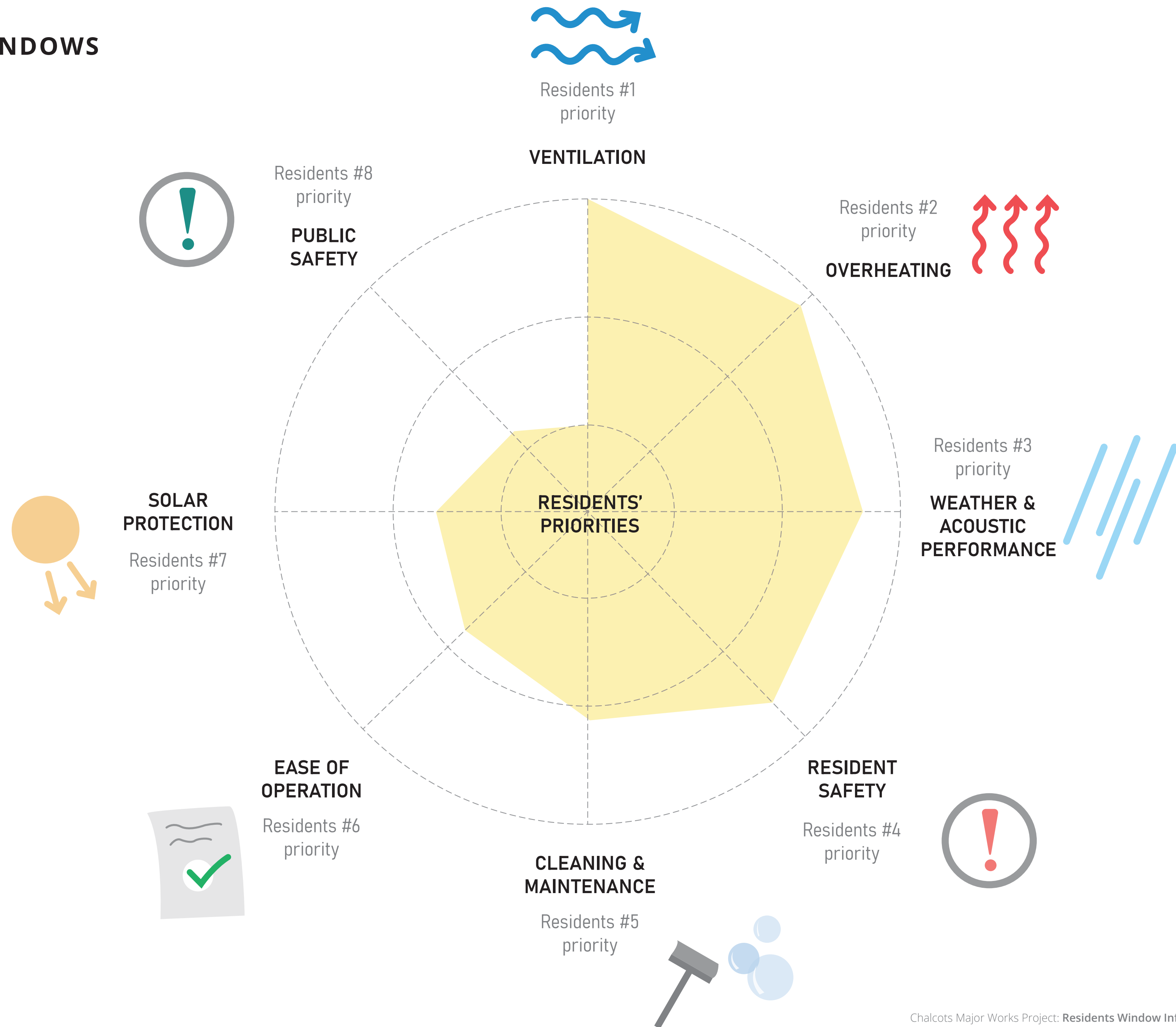

# INITIAL DESIGN DEVELOPMENT

## INITIAL COMPARISON OF WINDOW TYPES

In the following diagrams we have compared the performance of the existing (orange) and new (green) windows against the residents' priorities (yellow). The more the orange/green areas overlap with the yellow areas, the better the window matches the residents' criteria.



RESIDENTS' PRIORITIES

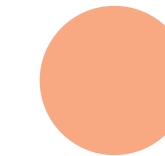

EXISTING WINDOW PERFORMANCE



NEW WINDOW PERFORMANCE

### EXISTING

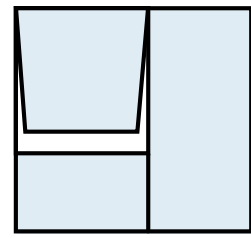

#### TILT OUTWARDS

This window option could provide sufficient ventilation if it opened further than its current settings, but this is not recommended as it increases the risk of falls - see Pages 20 & 21.

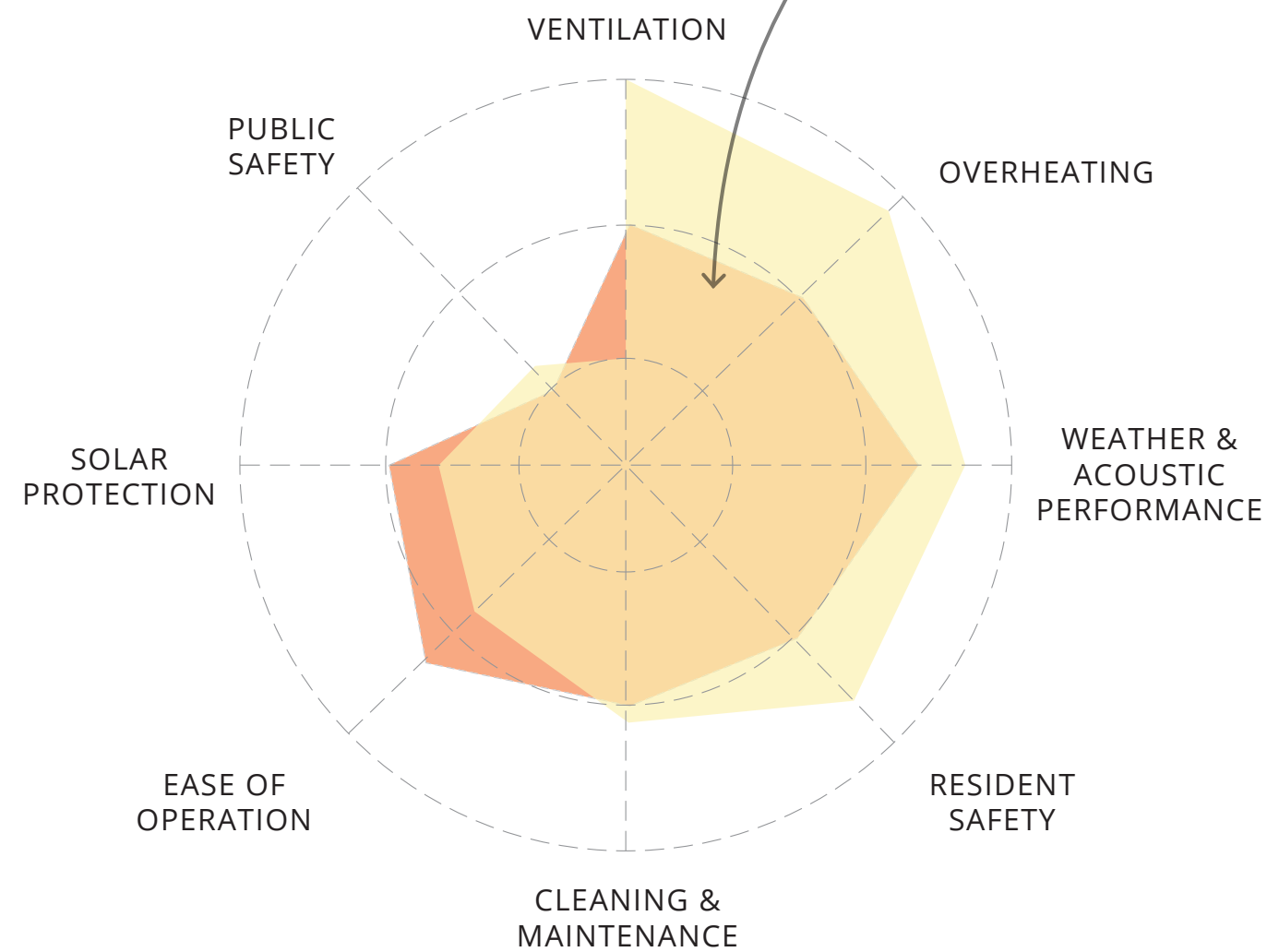

### NEW

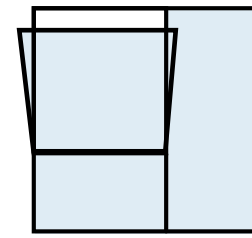

#### TILT INWARDS kitchen & bathroom window

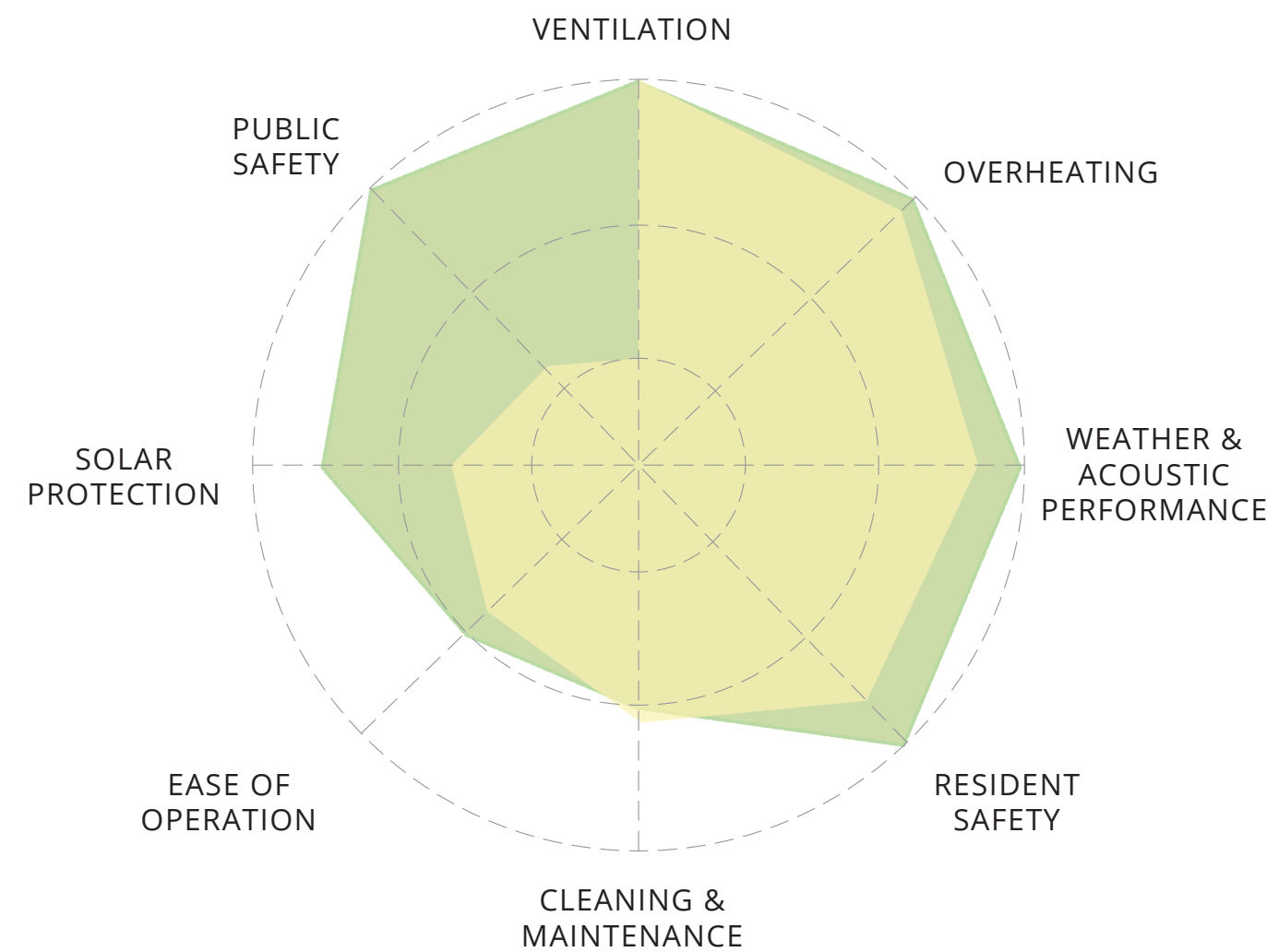

#### BEST OPTION KITCHENS & BATHROOMS

##### Advantages:

- High ventilation and overheating score
- High safety score due to bottom hung tilt in only window

##### Drawbacks:

- Handle is placed higher on the window frame

### NEW

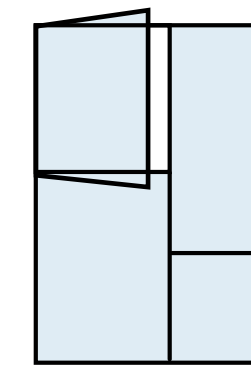

#### TILT & TURN INWARDS / LOWERED SILL main lounge & bedroom window

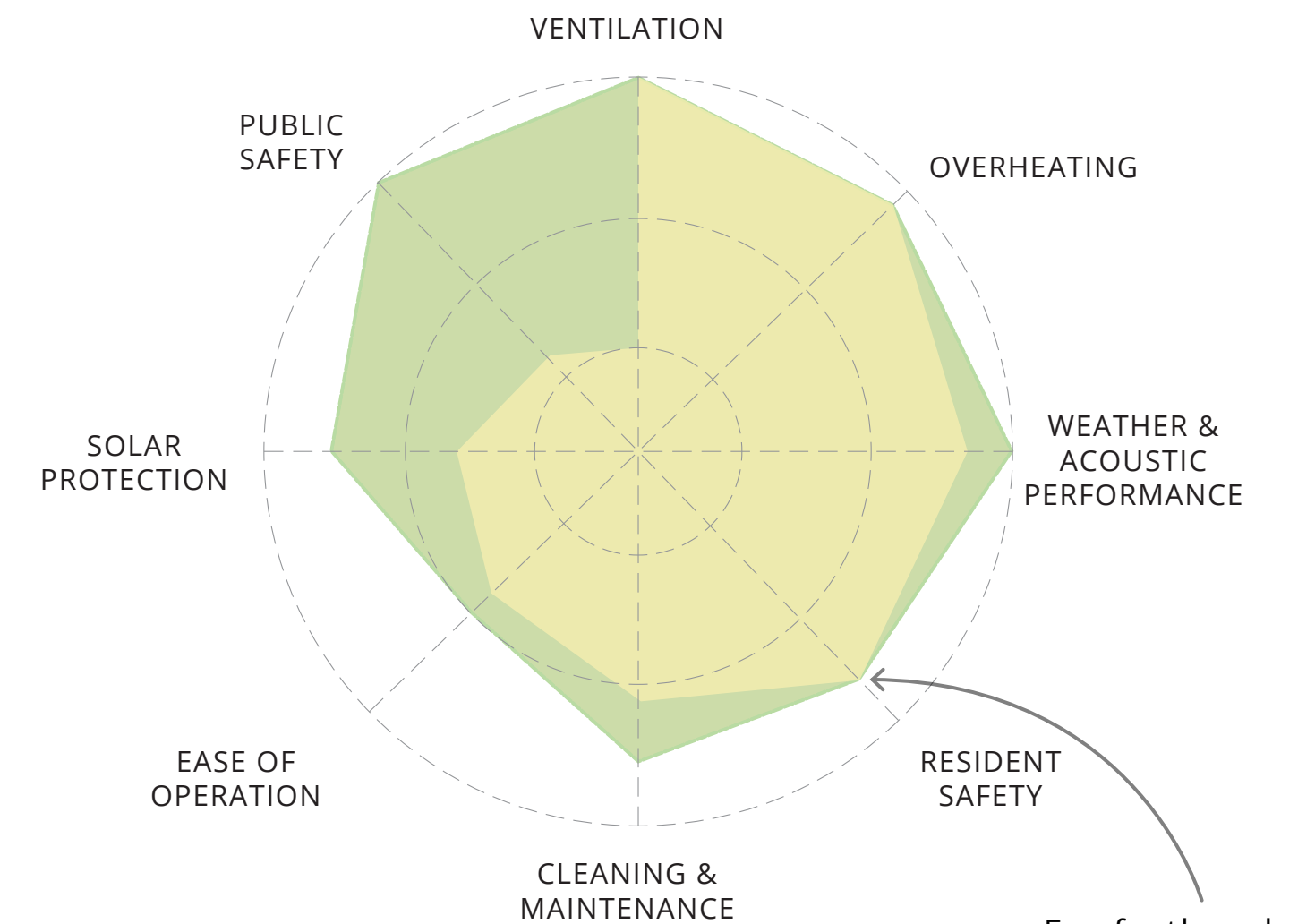

#### BEST OPTION LOUNGES & BEDROOMS

##### Advantages:

- High ventilation and overheating score
- High safety score due to inward opening window with lowered sill

##### Drawbacks:

- Handle is placed higher on the window frame

For further detail on risk mitigation see Pages 20-22.

INITIAL DESIGN DEVELOPMENT

ANALYSIS OUTCOME

Residents gave feedback on the window types in Camden’s June 2018 survey. 142 feedback forms were received by Camden out of a total of 716 households.

The two window options the residents most preferred were top hung, Tilt-outwards windows (as existing) and top/side hung, Tilt&Turn-inwards windows.

There was also an independent survey carried out in September / October 2019 and 222 residents participated out of 672 households (flats with Camden tenants and leaseholders residing on the estate excluding empty properties and leaseholder flats that are tenanted). 65% of residents favoured or didn’t mind the new windows with lowered sill.

All proposed options met Building Regulation standards for existing buildings. However not all had the potential for improvement of performance compared to the existing.

**Overall, inwards-opening tilt&turn windows performed best against the assessment criteria, and were the preferred option based on resident feedback.**

EXISTING

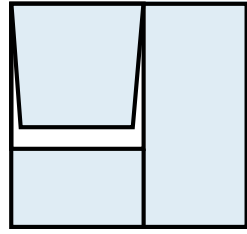

TILT OUTWARDS

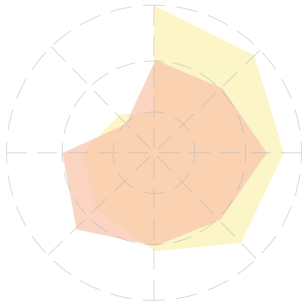

Results from the assessment criteria & resident priorities analysis, as shown on Page 5

NEW

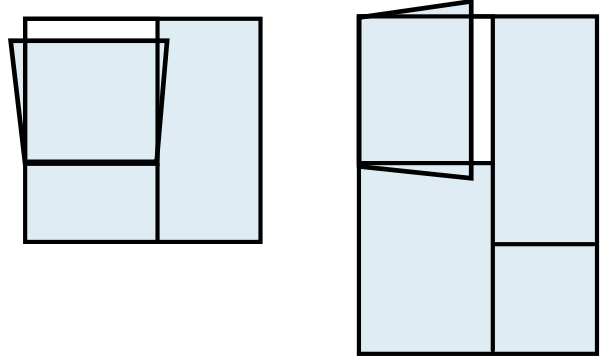

TILT & TURN INWARDS / LOWERED SILL

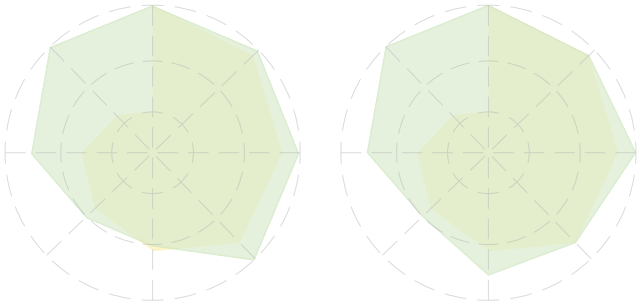

Feedback from Taplow, Burnham, Bray & Dorney

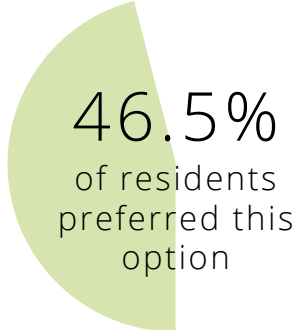
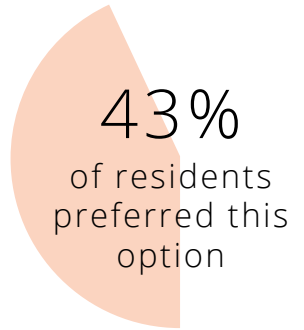

Feedback from Blashford

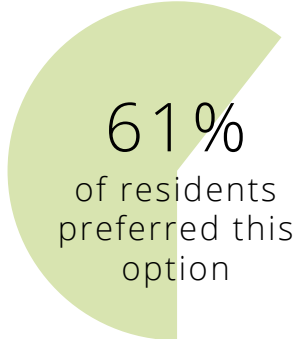
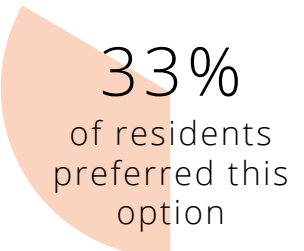

Total feedback across The Chalcots

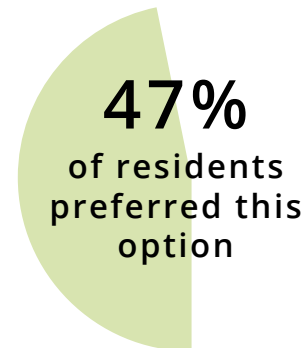
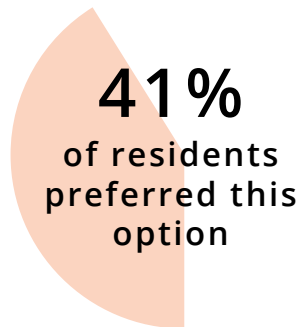

**NEW WINDOWS: SUMMARY**  
**BEDROOM ILLUSTRATION (EXAMPLE)**

Resident has chosen to unlock the window to open a maximum of 30cm (but no further) as there is a responsible adult in the room with the child

Other opening options are 10cm tilt or 90° turn position.

Children should not be left unsupervised in rooms where the window is open 30cm or 90° in the turn position. Page 13 shows restrictor options.

30cm is (generally) within the window sill depth so does not take up space in the room

Window can be opened/closed without leaning out



Resident keeps personal wallpaper or paint. Wider reveals will cover any damage from window replacement works.

Option for curtains in the window reveals

Openable window section can be cleaned easily from the inside

Reduced risk of overheating as the new glass lets less heat in

Option for radiator in the window sill to save space

*Illustrative example bedroom on typical floor to show new tilt & turn windows. Furniture, wallpaper, radiator and curtains vary per flat.*

**NEW WINDOWS: SUMMARY**  
**LOUNGE ILLUSTRATION (EXAMPLE)**

Resident has chosen to unlock the window fully beyond 30cm for maximum ventilation.

Children should not be left unsupervised in rooms where the window is open 30cm or 90° turn position. Page 13 shows restrictor options.

Window can be opened/closed without leaning out

Openable window section can be cleaned easily from the inside

Reduced risk of overheating as the new glass lets less heat in

Choice of radiator to save space



Option for curtains in front of window reveals

Resident keeps personal wallpaper or paint. Wider reveals will cover any damage from window replacement works.

Space for furniture in front of fixed window

Lower glazed panels may be covered with film to make the window opaque if required to prevent vertigo

Radiator in window sill with space for plants or other objects on the sill

*Illustrative example lounge on typical floor to show new tilt & turn windows. Furniture, wallpaper, radiator and curtains vary per flat.*



**NEW WINDOWS: SUMMARY**  
**KITCHEN ILLUSTRATION (EXAMPLE)**

Resident has chosen to unlock window so it can open 40° for better ventilation

Window can be reached more easily over counters

Space for storage or plants on the window sill



Resident keeps personal wallpaper or paint. Wider reveals will cover any damage from window replacement works.

All kitchen windows have a close-assist mechanism for the 40° setting to make them easier and lighter to close.

For further accessibility, the window handle can be extended or an electric switch added

*Illustrative example kitchen on typical floor to show the new tilt only window. Furniture, fittings, wallpaper and curtains vary per flat.*

NEW WINDOWS: SUMMARY  
BATHROOM ILLUSTRATION (EXAMPLE)

Bathroom window is open 10cm inwards for normal background ventilation

Frosted glass allows for privacy

The blind can close for further privacy while the window is open 10cm



Blinds can close for further privacy while the window is open

Resident keeps personal tiles or paint. Wider reveals will cover any damage from window replacement works.

Space for storage on the window sill

*Illustrative example bathroom to show new tilt only window. Furniture, fittings, tiling and curtains vary per flat.*



# WINDOW OPERATION

## TYPICAL WINDOW DIMENSIONS

**Lounge Window:**

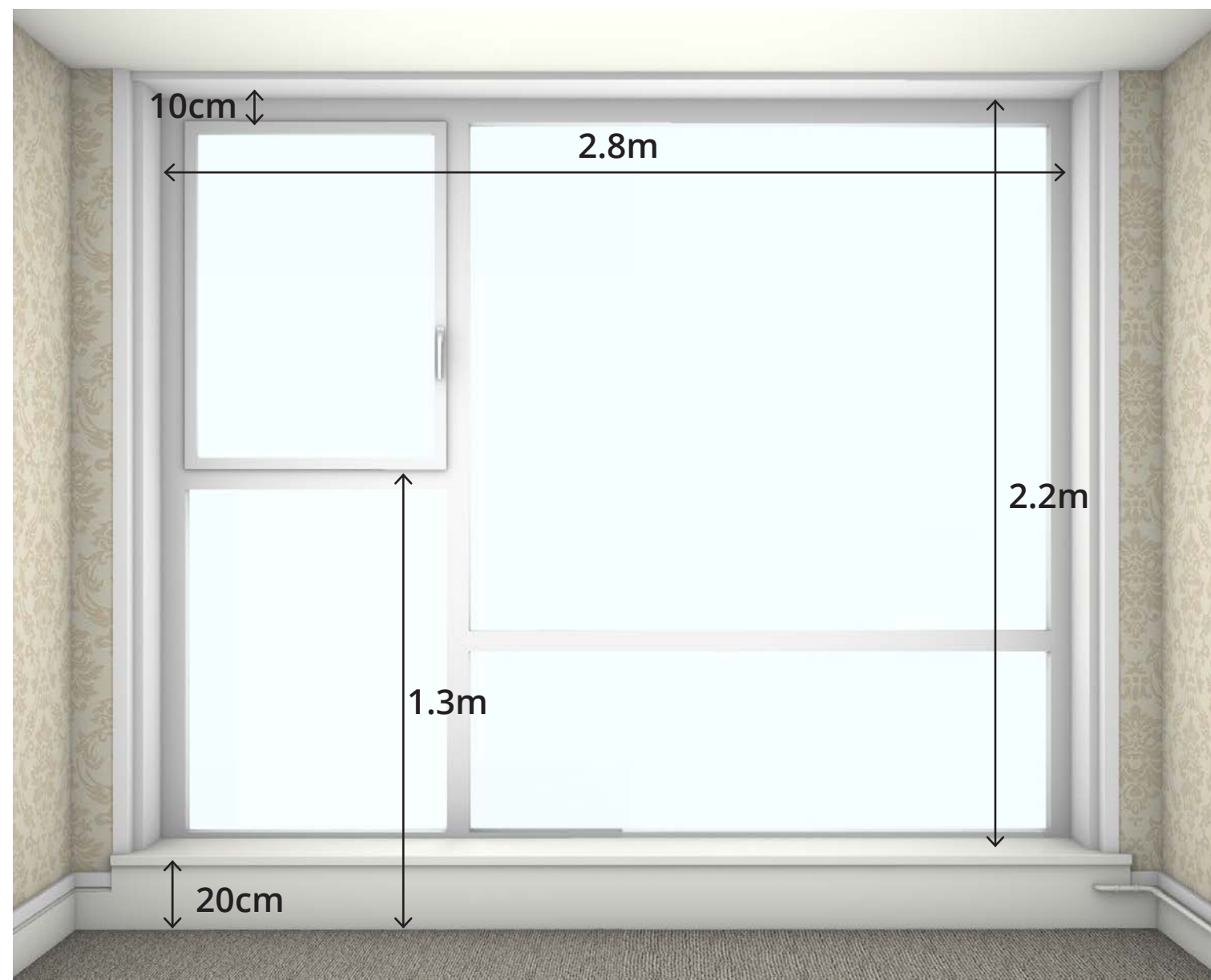

**Bedroom Window:**

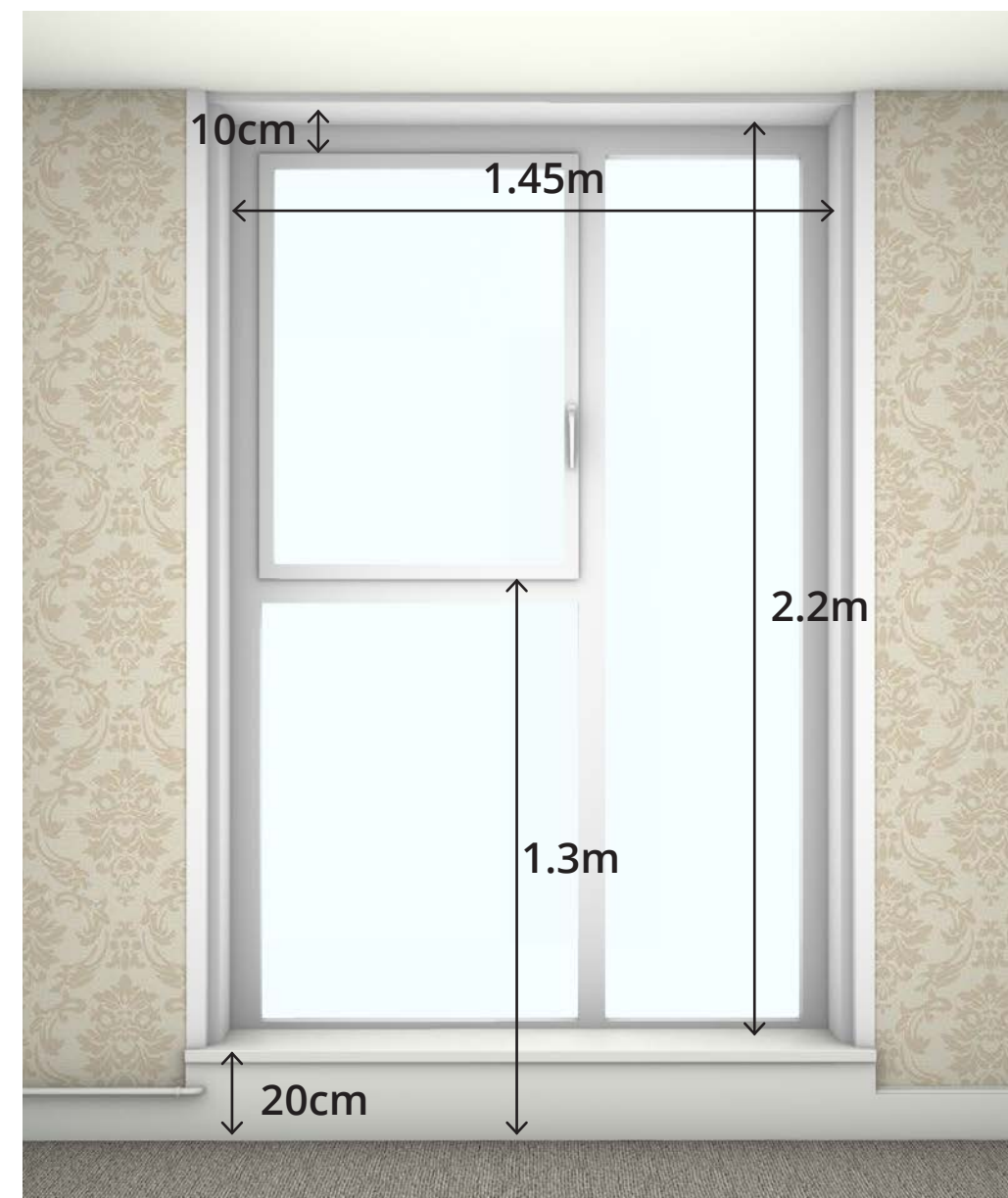

**Kitchen Window:**

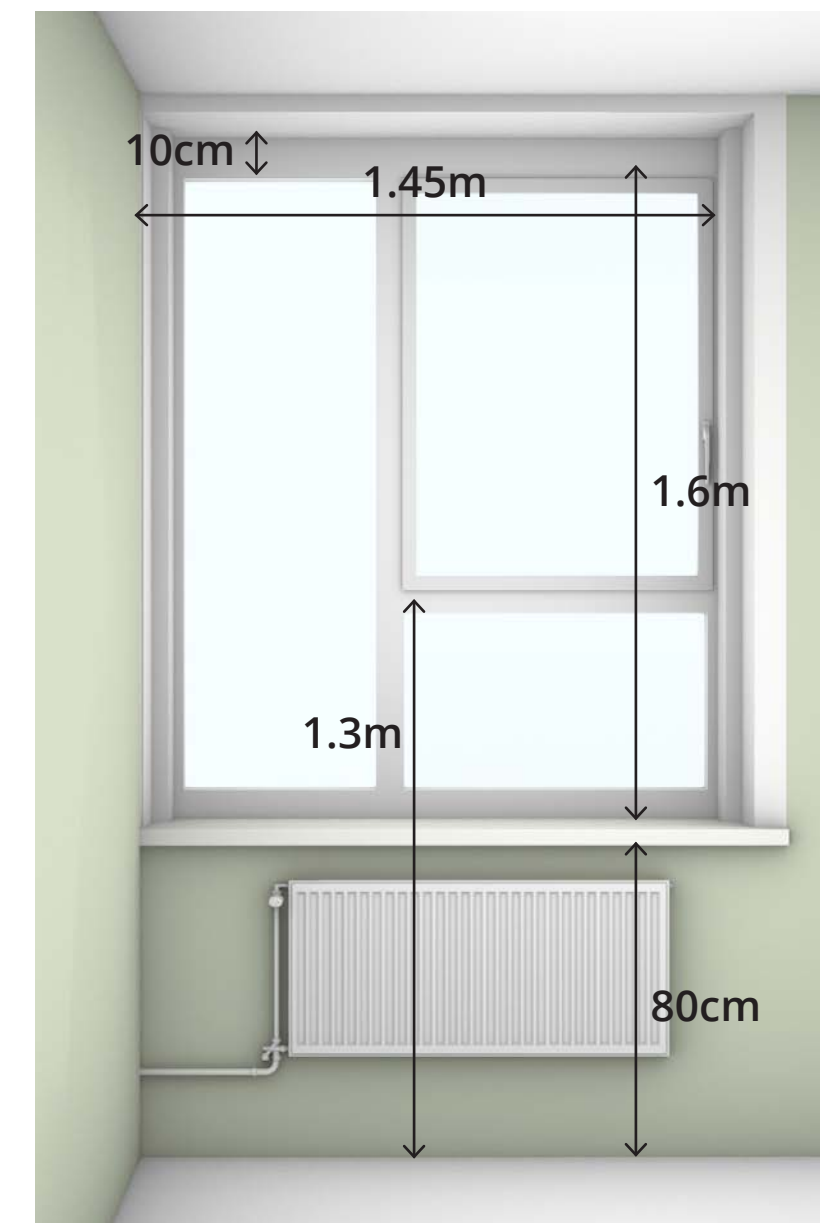

**Bathroom Window:**



All dimensions are nominal and exact internal dimensions may vary slightly as the design develops and further site surveys are completed.

WINDOW OPERATION  
**LOUNGE / BEDROOM OPENING POSITIONS**

**EXISTING**

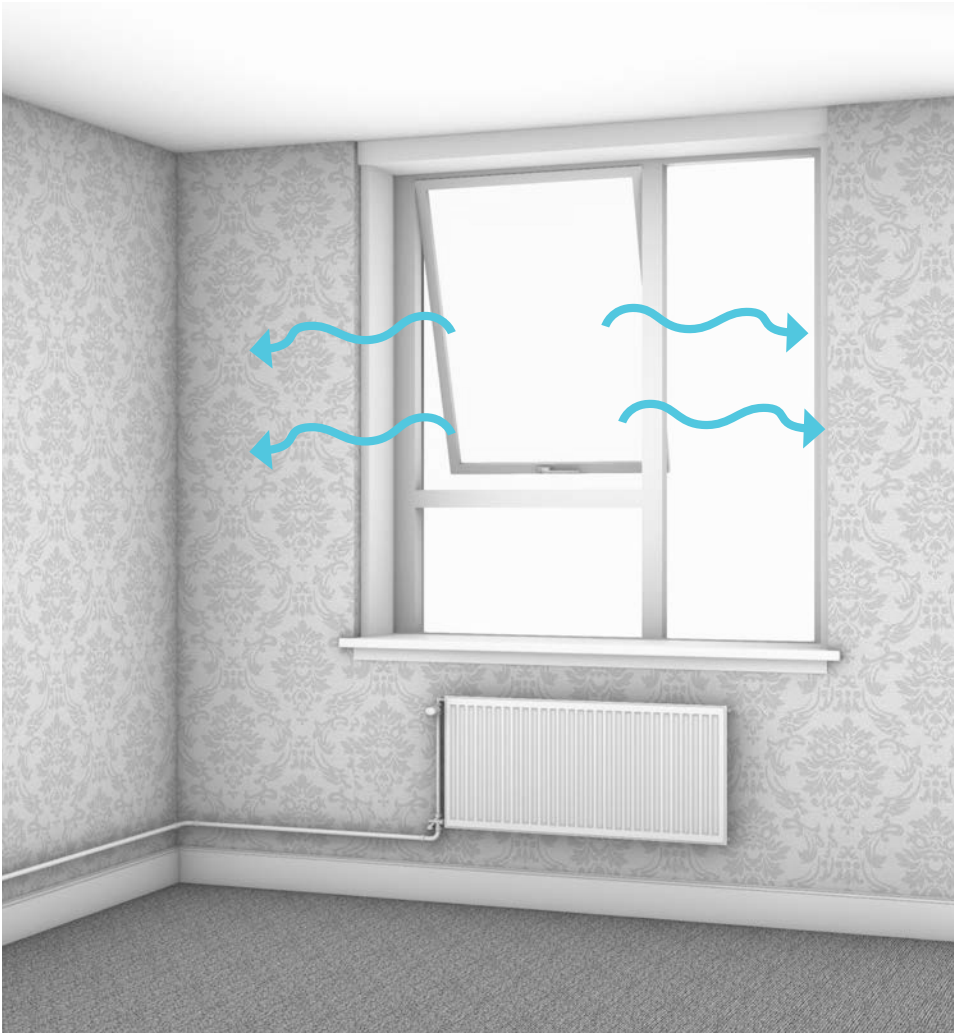

All existing windows open 10cm and can be released further to open 30cm. The 10cm is a child-safe setting. Children should be supervised if the window is in the 30cm position.

**10cm Tilt**

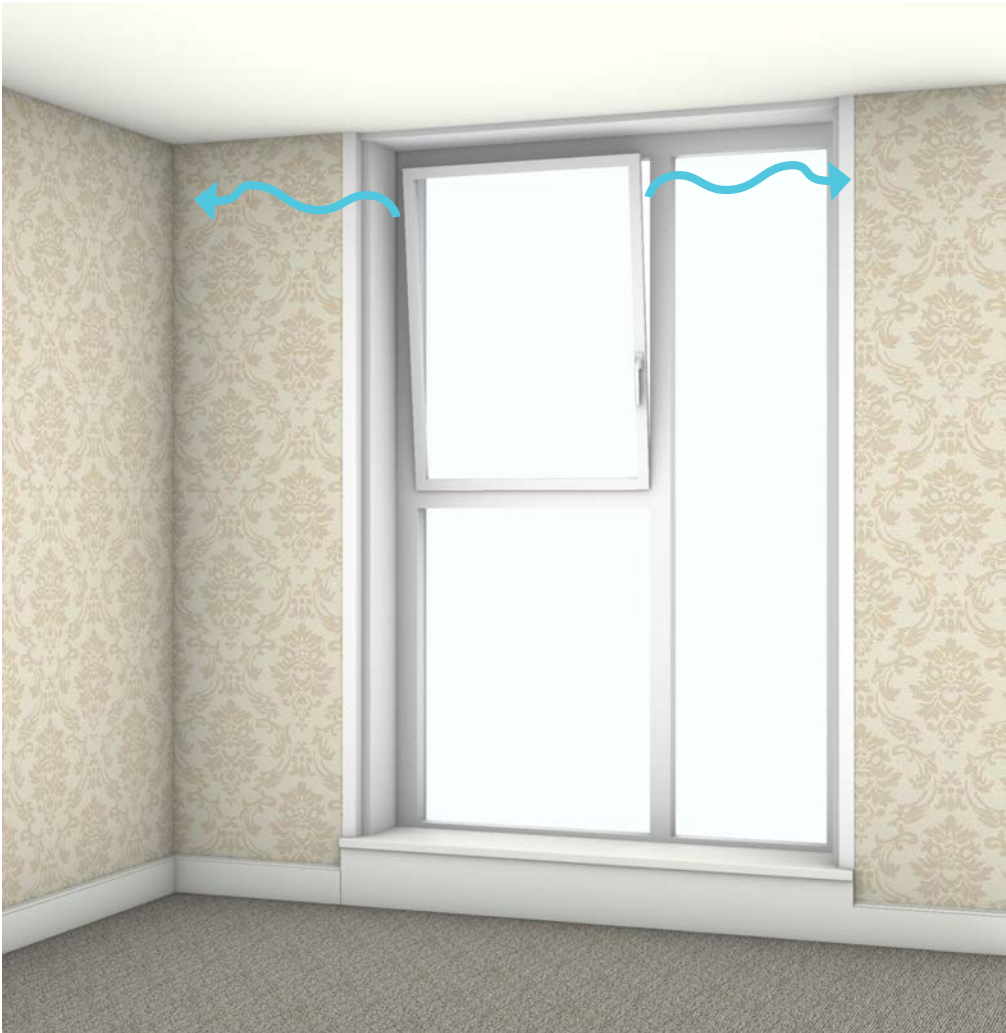

All new windows can open 10cm. This provides ventilation and is a child-safe setting. All new tilt & turn windows will include mishandling blocks which prevent the window becoming accidentally disengaged in both tilt & turn mode.

**30cm Turn**  
 Unlock with key

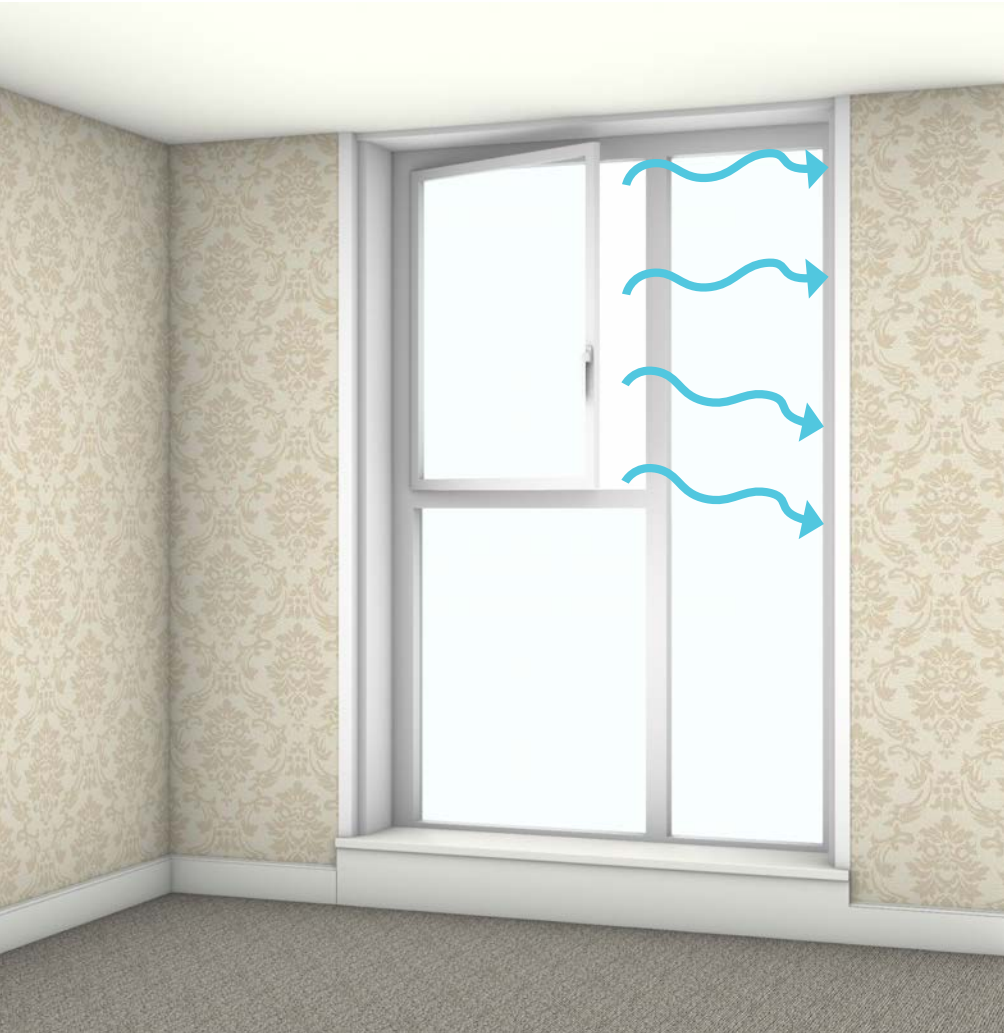

All new windows have the option to open 30cm if you choose to unlock it with a key. This is optional and the window may be locked to only open 10cm. Children should be supervised if the window is in the 30cm position.



**90° Turn**  
 Unlock with second key

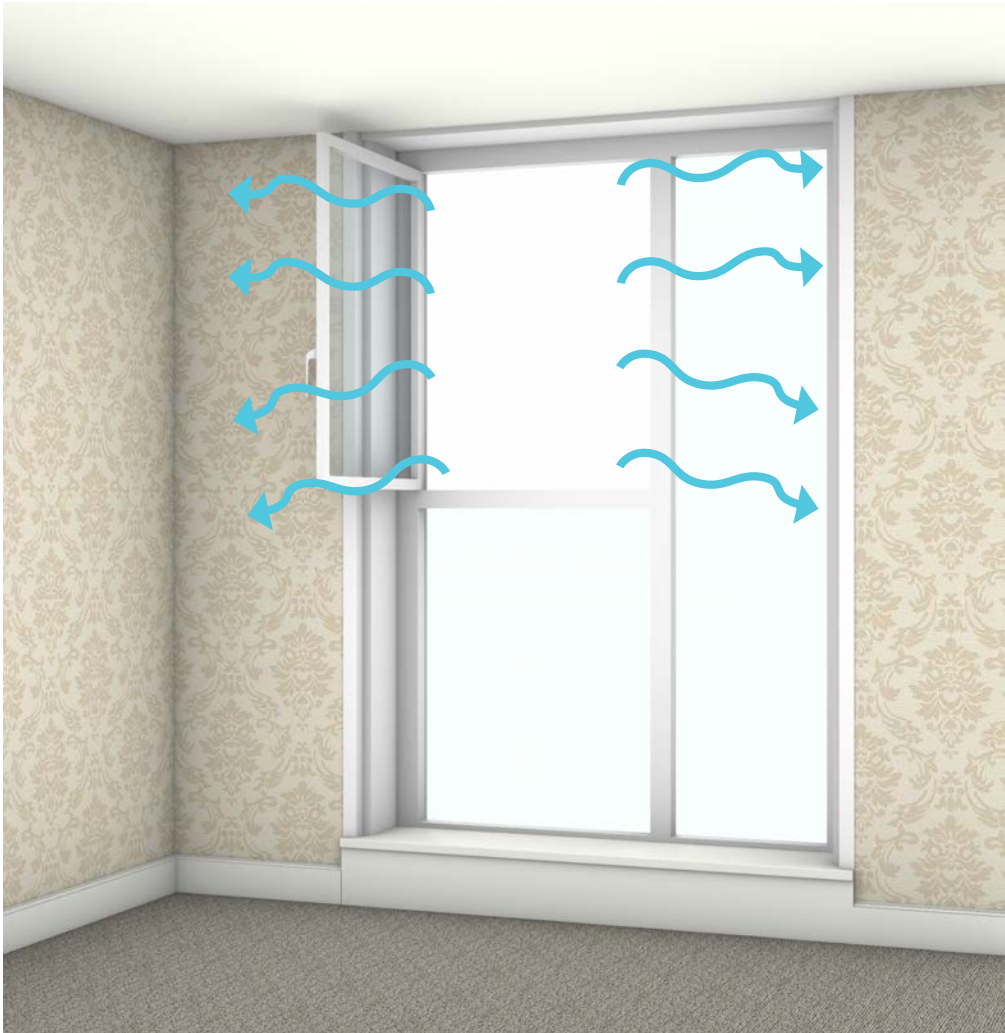

All new windows have the option to open 90° if you choose to unlock a second lock with the second key. This is optional and if preferred the window can be locked so it can only open 30cm. This option is for purge ventilation purposes (see Chapter 5). Children should be supervised if the window is in the 90° position.



# WINDOW OPERATION

## KITCHEN / BATHROOM OPENING POSITIONS

### EXISTING

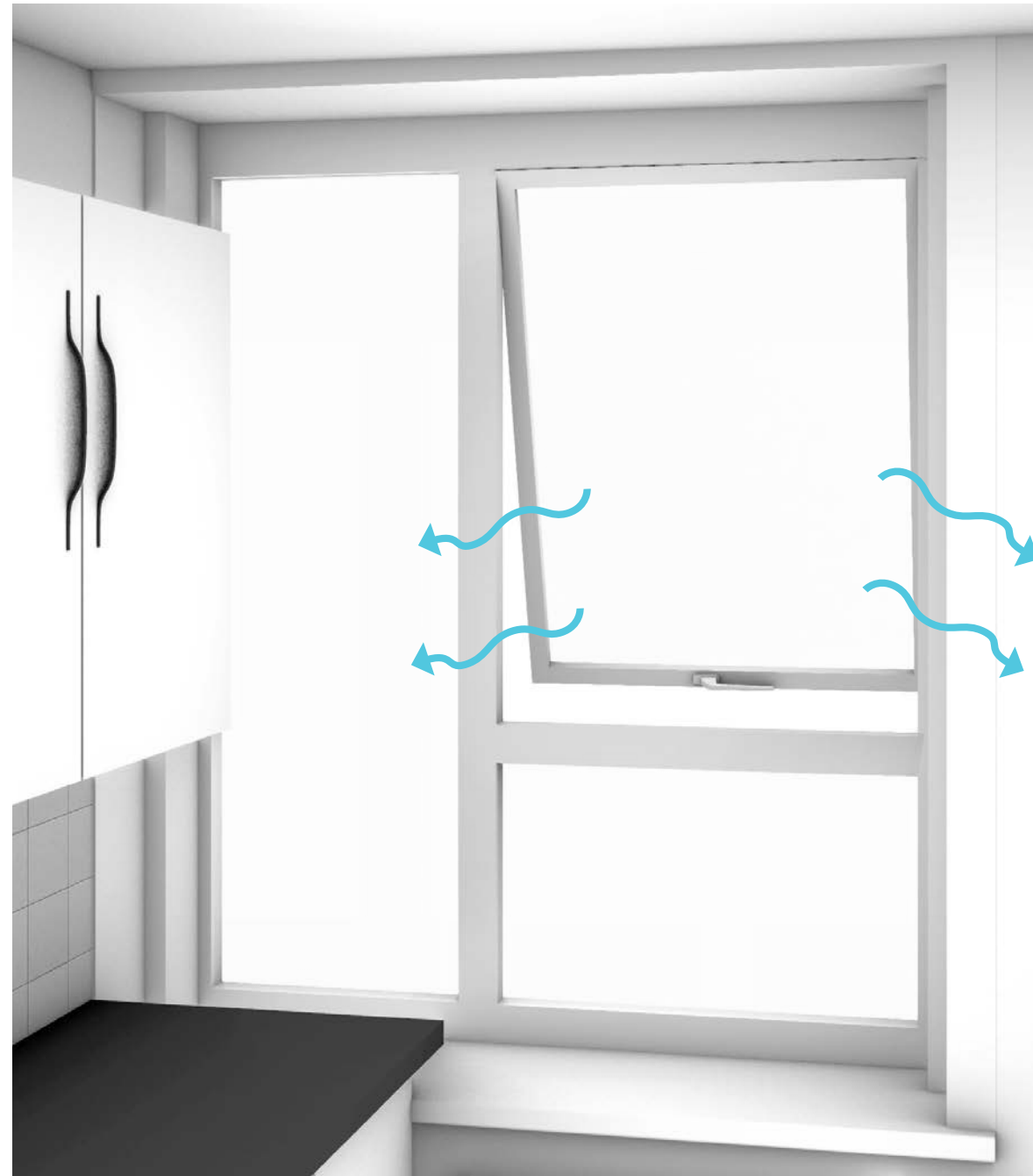

All existing windows open 10cm and can be released further to open 30cm. The 10cm is a child-safe setting. Children should be supervised if the window is in the 30cm position.

### 10cm Tilt

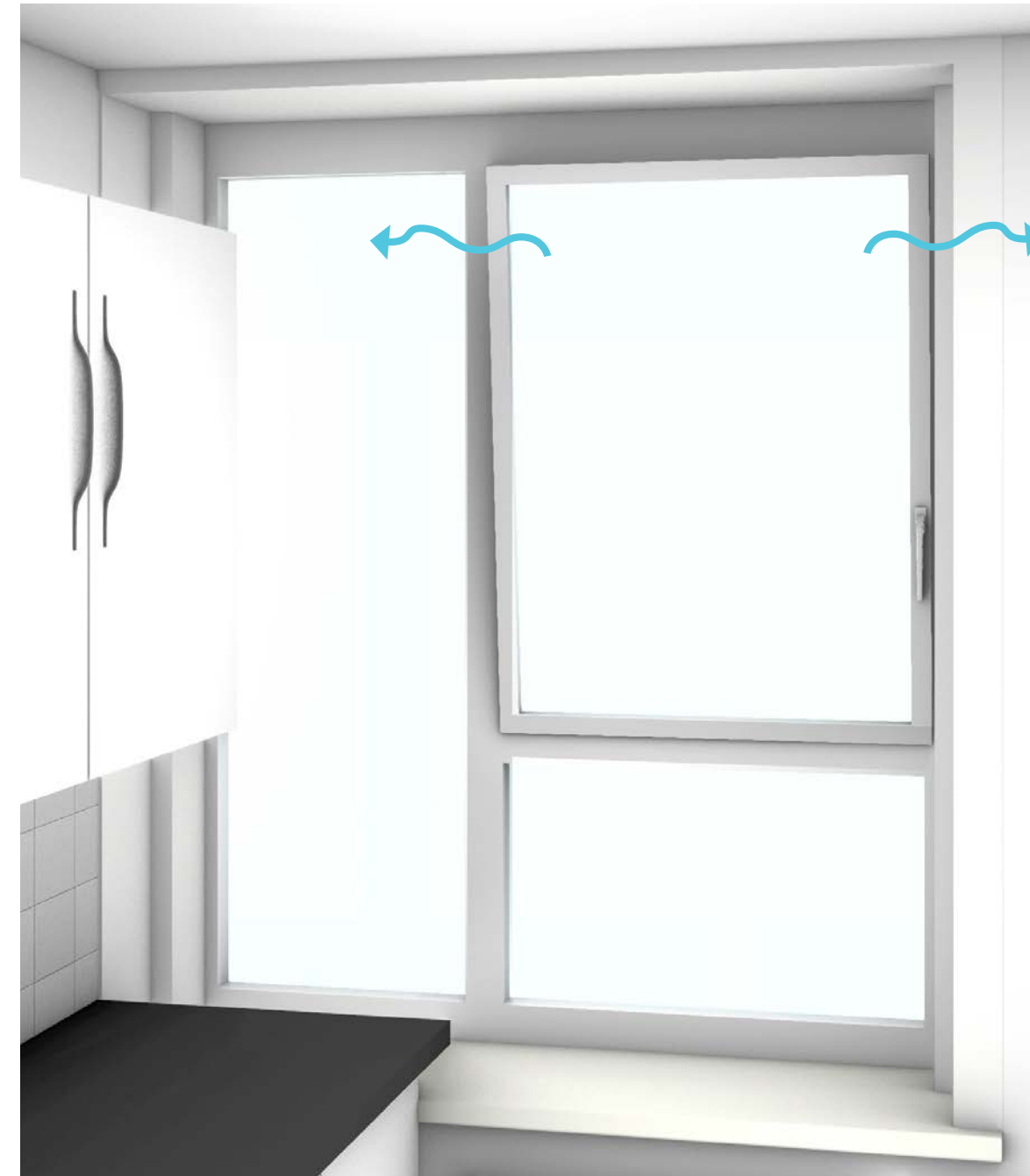

All new windows can open 10cm. This provides ventilation and is a child-safe setting.

### 40° Tilt Unlock with key

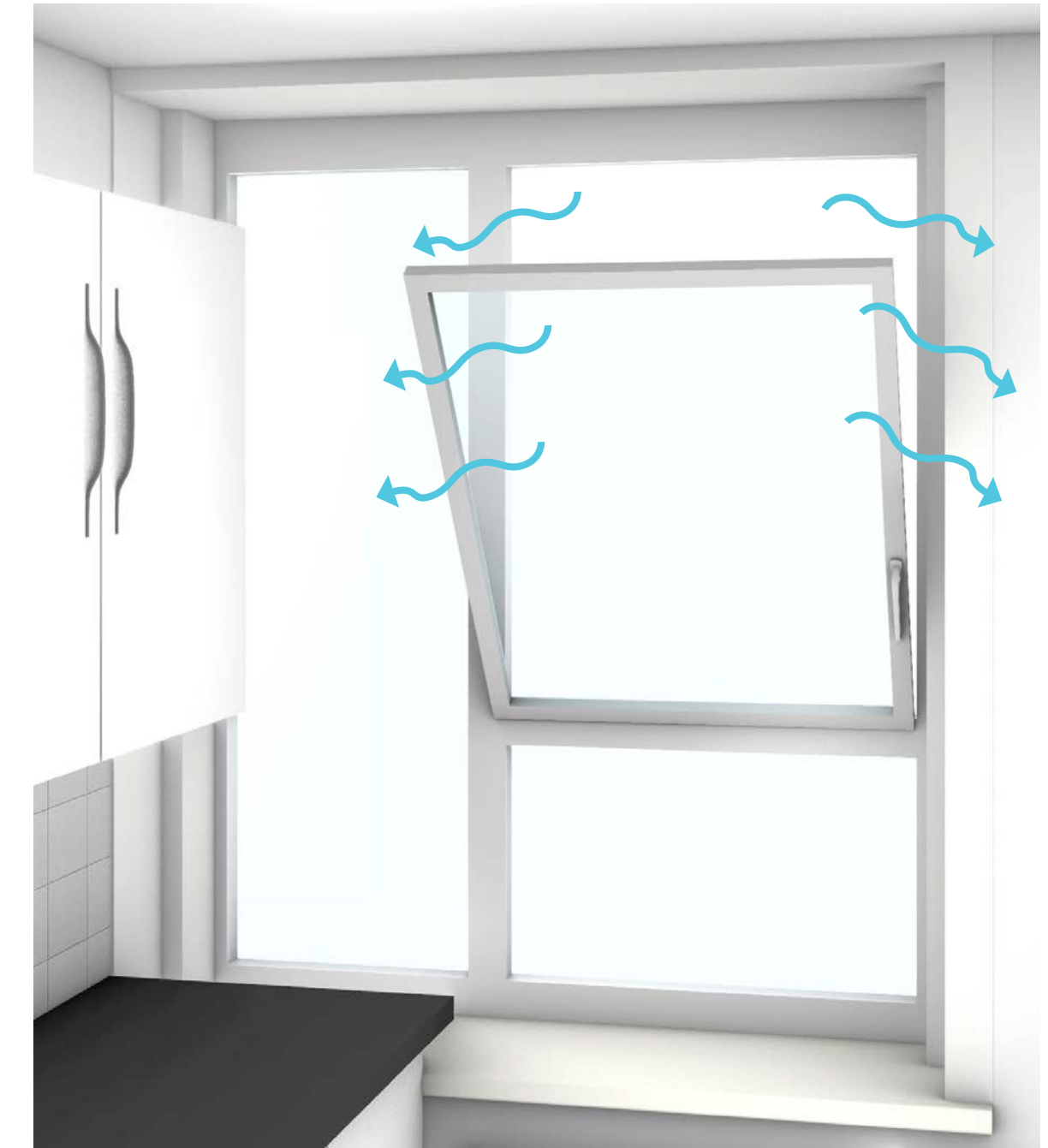

All new windows have the option to open 40° if you choose to unlock it with a key. This is optional and the window may be locked to only open 10cm. This option is for purge ventilation purposes (see Chapter 5).



*Note: A third setting cannot be added because this is not possible for technical reasons. The window cannot be restricted to 30cm as this would not meet ventilation requirements (see Pages 24 & 25).*



WHAT REGULATIONS DOES THE TECHNICAL WINDOW DESIGN INFORMATION BOOKLET REFER TO?

REGULATORY TOPIC:	<p><b>CDM REGULATIONS</b></p> <p><i>Full name: The Construction (Design and Management) Regulations 2015</i></p>	<p><b>THE BUILDING REGULATIONS</b></p> <p><i>The Approved Documents are guidance for how to comply with the Building Regulations. Key Approved Documents referred to in this document and how they apply to the Chalcots Major Works Project are outlined below:</i></p>		
REQUIREMENT FOR CHALCOTS MAJOR WORKS PROJECTS:	Designer duties	Approved Document F	Approved Document K	Approved Document L
	Health and safety	Purge ventilation	Protection from falling	Overheating
	<p><b>Designers must comply with their duties under the CDM Regulations</b></p> <p>CDM regulations require all reasonable steps to be taken to avoid or mitigate risks.</p> <p>Using CDM requirements will not lead to clear pass / fail criteria. They demonstrate that a process of risk assessment and mitigation has been followed and documented. For Chalcots, CDM regulations are applicable to the selection of window opening type, as they are to all design decision for a construction project.</p>	<p><b>As the Chalcots buildings are existing buildings, there is a requirement to meet at least the existing performance, but the windows do not need to meet current regulations relating to Approved Document F.</b></p> <p>However, ventilation was raised as a concern by residents and identified as a CDM risk therefore we have aimed to <b>improve</b> performance beyond these requirements</p>	<p><b>The windows need to meet these regulations</b></p>	<p><b>As the Chalcots buildings are existing buildings, there is a requirement to meet at least the existing performance, but the windows do not need to meet current regulations relating to Approved Document L</b></p> <p>However, overheating was raised as a concern by residents and identified as a CDM risk therefore we have aimed to <b>improve</b> performance beyond these requirements</p>
WHERE TO FIND MORE INFORMATION:	<p>Chapter 4: Safety, Pages 20-22 Chapter 5: Ventilation Chapter 6: Overheating</p>	<p>Chapter 5: Purge Ventilation</p>	<p>Chapter 4: Safety, Page 21</p>	<p>Chapter 6: Overheating</p>





**EXISTING WINDOWS**  
**EXISTING WINDOW DIMENSIONS**



*Good ventilation and a comfortable room temperature, as well as residents safety, are top priorities for the new windows*

*The existing windows complied with current safety standards, but **we want to improve the performance of the new windows** by improving ventilation to reduce overheating, while maintaining safety standards.*

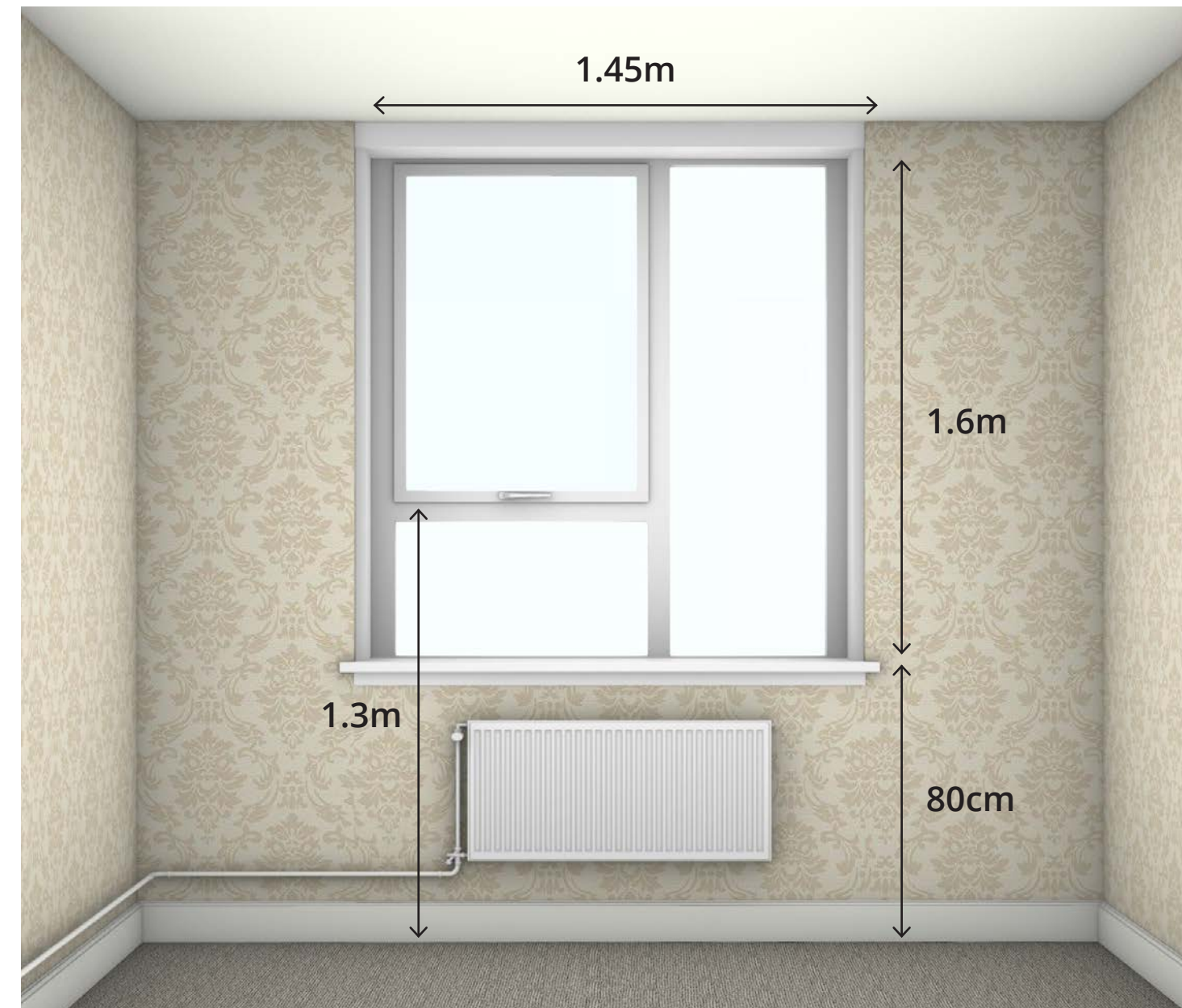

Existing Bedroom Window

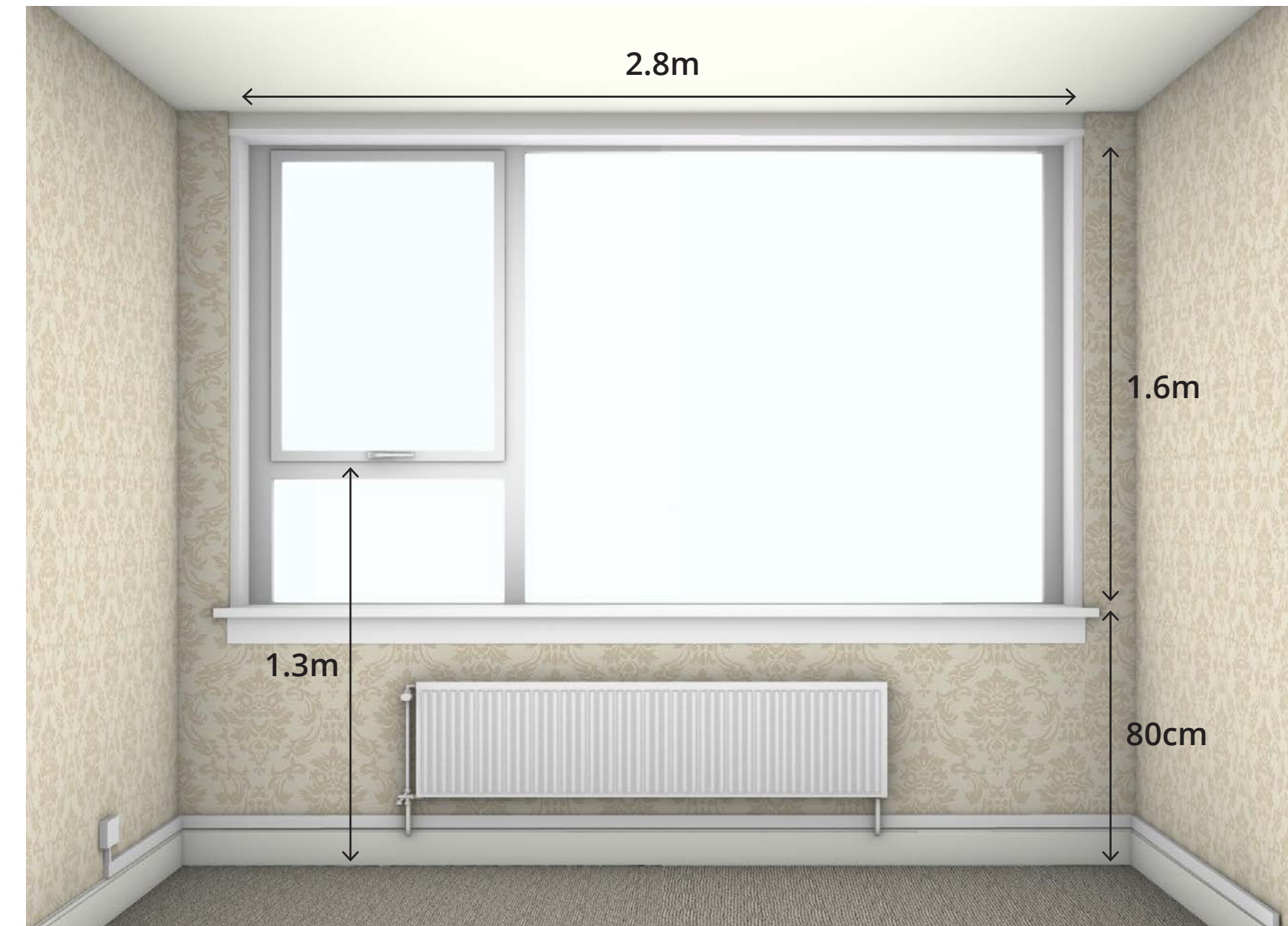

Existing Lounge Window



Closed position.



Open position: 10cm.  
 This is a child-safe setting.



Open position if released further: 30cm.  
 Children should be supervised if the window is unlocked to 30cm.

Please note that dimensions are approximate and vary slightly between flats.

**WHY DO THE EXISTING WINDOWS NEED REPLACING?**

**WHY DO WE HAVE TO REPLACE THE WINDOWS?**

- A number of window opening elements have fallen off the building in high winds in the past. This represents an unacceptable risk to the public so it needed to be addressed.
- The existing window system includes combustible insulation in the spandrel panels and around some of the reveals so a replacement is required to comply with current fire regulations.
- Replacement windows will provide the opportunity to improve window performance (thermal insulation, ventilation and prevention of overheating) to future proof the building and increase residents comfort and well-being.



**WHAT STANDARDS DO THE NEW WINDOWS NEED TO MEET?**

**1. COMPLY WITH SAFETY REGULATIONS AND GUIDANCE**

When you replace the windows, the new windows must meet or exceed the minimum safety standards set out in the regulations and guidance (Building regulations Part K).

**2. IMPROVE VENTILATION & OVERHEATING**

Existing windows will have met the regulations for ventilation when they were installed in 2006. However, the regulations have been up-dated twice since then in 2010 and in 2013 and the performance requirements have increased.

There is no regulatory requirement for an existing building to meet current ventilation and overheating standards (Building regulations Part F) but it would be irresponsible to not use the opportunity that replacement presents to provide substantial improvement or even meet current regulations on some criteria.



**THE WINDOW DESIGN PROCESS:**

The key focus was to find a design that met residents needs, met safety standards and improved ventilation and overheating.

The window design process:

1. Residents consultation to understand concerns and priorities. *(see Page 4)*
2. Analyse which type of window best meets the residents needs *(see Page 5)*
3. Develop the design to reduce safety risks *(see Chapter 4: Safety)*
4. Develop the design to substantially improve ventilation and overheating *(see Chapter 5: Ventilation & Chapter 6: Overheating)*

# NEW WINDOWS

## WHY ARE THE NEW WINDOW SILLS LOWERED IN LOUNGES AND BEDROOMS?

### 1. ANALYSE THE EXISTING WINDOWS

The design process started by analysing the performance of existing windows to see if they can be replaced with the same design.

Residents raised issues about overheating and ventilation. These were taken seriously and added to the projects' Risk Register as required under the CDM Regulations (see Page 16).

In addition, designers had concerns about the risk of falling if a child stood on the window sill (Page 21), the risk of leaning out of the window, and the risk of windows falling off the building (Page 22).

#### EXISTING WINDOWS:

- ✓ Meets current Building Regulations on safety from falls
- ✗ Insufficient ventilation and overheating were identified as key issue
- ✗ CDM risk assessment highlighted risk of falls due to accessible window sill which could be climbed onto (see Page 21)



### 2. IMPROVE OVERHEATING & VENTILATION

One of the key ways to reduce overheating is to provide better ventilation. The new windows need to have an option to open further to provide better ventilation. Chapters 5 & 6 describe ventilation and overheating issues in more detail.

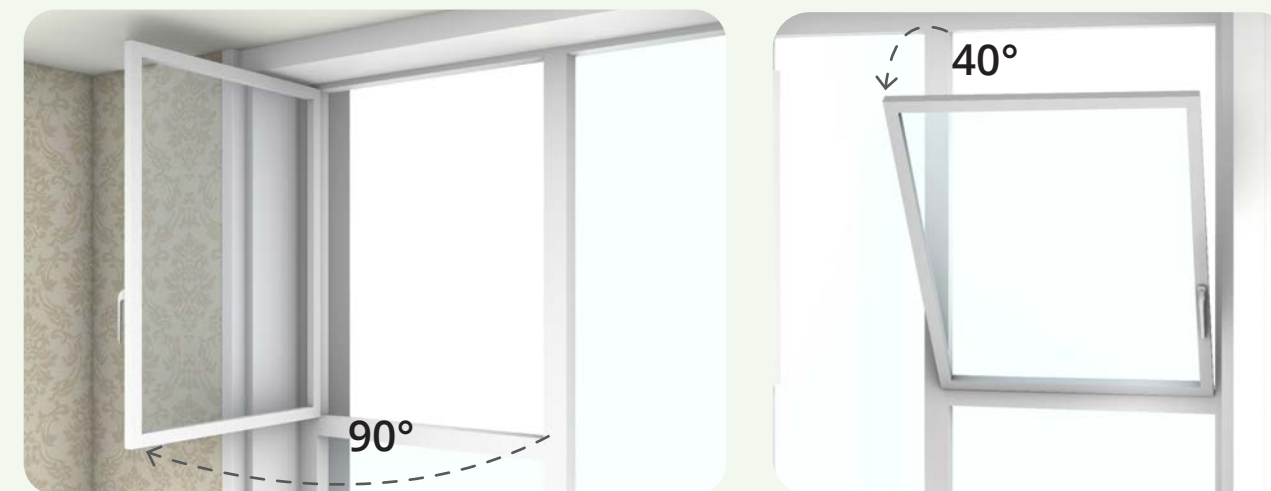

*It is optional for residents to unlock their windows for purge ventilation and these settings can be locked for normal use as shown on Pages 13 & 14.*

- ✓ Meets current Building Regulations on safety from falls
- ✓ Provides much improved ventilation and reduced risk of overheating
- ✗ CDM risk assessment highlighted a risk of falls due to accessible window sill which could be climbed onto (see Page 21)



### 3. IMPROVE SAFETY

In addition to the overheating and ventilation risks identified by residents, the increased risk of falling out of the window if someone stood on the sill was identified. This is described in more detail on Page 21.

To mitigate this risk, the window sill was lowered so that even if you stand on the window sill, there is still a balustrade-height barrier ('guarding height') between you and the open window.

In kitchens and bathrooms lowering the window sill is not possible, therefore a tilt-only window is used to reduce the risk of falls.

#### NEW WINDOWS:

- ✓ Meets current Building Regulations on safety from falls
- ✓ Provides much improved ventilation and reduced risk of overheating
- ✓ Risk of falls identified in CDM risk assessment is mitigated by dropping the sill (see Page 21)



# NEW WINDOWS

## RISK OF FALL: GUARDING HEIGHTS

### Guarding height regulations

The **Building Regulations Approved Document Part K 2010 'Protection from falling, collision and impact'** set out the minimum guarding heights for balconies and openable windows.

Diagram 3.1 of Part K requires that, in residential buildings, open windows must be 80cm above floor level to provide a 80cm guarding height for protection from falling.



Regulatory guarding height below an open window

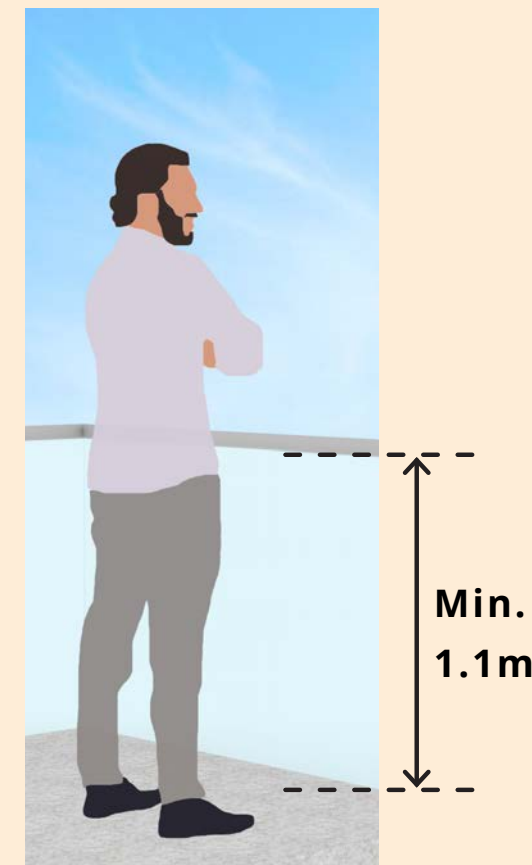

Regulatory guarding height for a balcony

### Guarding height guidance

The **Building Control Alliance (BCA) Guidance Note 16** gives further guidance on guarding heights for open windows. It is not regulatory guidance, but it provides a useful benchmark to improve safety beyond the regulations.

Window sills above 60cm are not considered climbable. Therefore the guarding height is measured from the floor to the open window.

Window sills under 60cm are considered climbable. Therefore the guarding height is measured from the top of the sill to the open window.

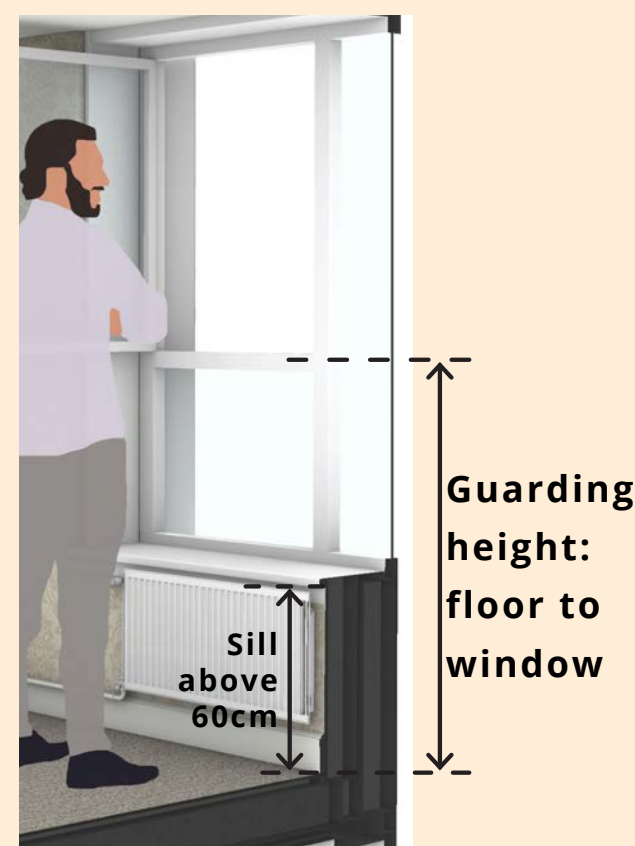

BCA Guidance takes into account the climb-ability of window sills



### CURRENT WINDOWS GUARDING HEIGHTS

The current window guarding heights do meet the regulations. However, Camden have decided to increase the safety of the window beyond the minimum requirements and beyond the BCA guidance.

✓ Windows exceed the guarding height regulations and BCA guidance

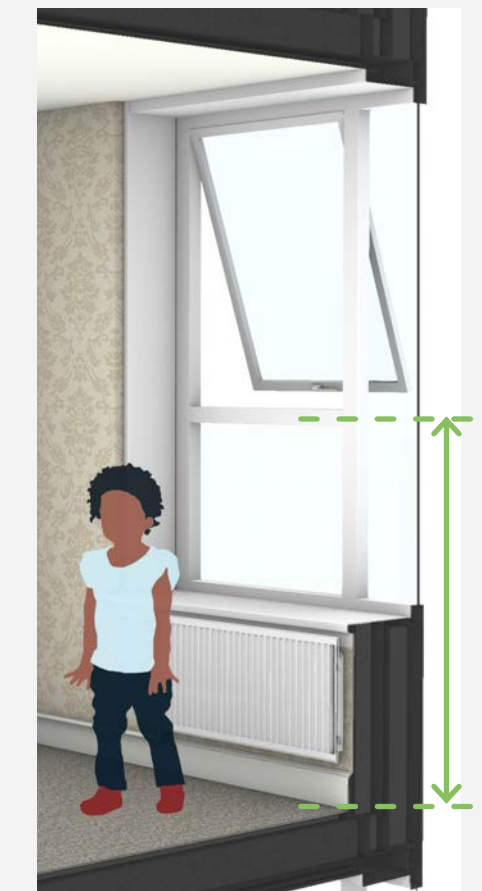

Even though the windows meet guarding height regulations and guidance advice, the risk of fall if a child climbs onto the window sill, which was identified in the CDM risk assessment, is not mitigated.

! Potential safety risk

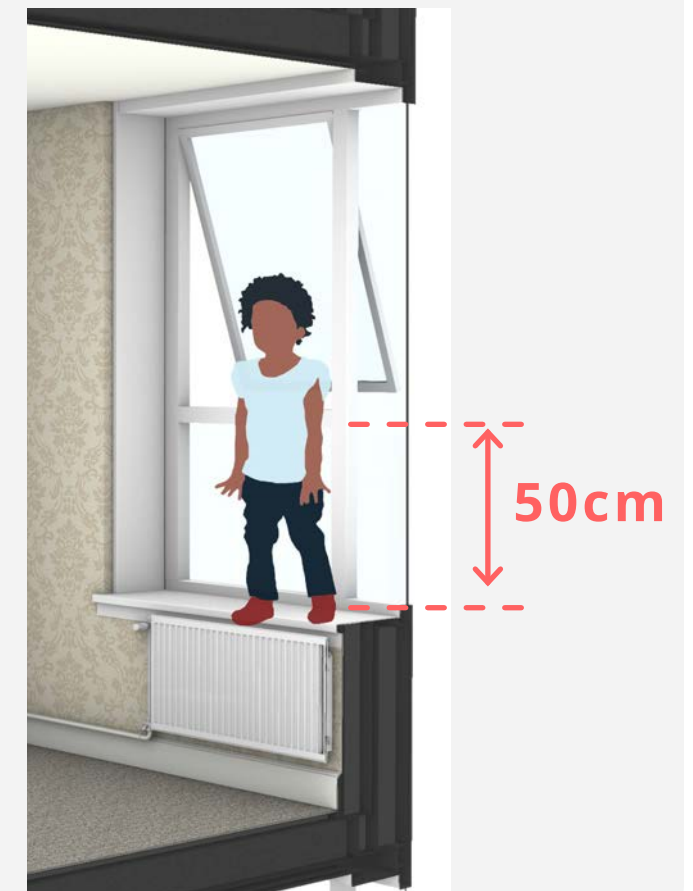

### NEW WINDOWS GUARDING HEIGHTS

Therefore, in order to mitigate the risk of standing on the sill, two further safety measures have been taken for the new Chalcots windows. For further explanation as to why these measures are in place, see Page 20.

**1. The guarding height will be measured from the window sill, to mitigate the risk of fall if someone stands on the window sill**

**2. The guarding height will be 1.1m, which is the minimum guarding height for a balcony.**

Rather than using a typical window guarding height (80cm), a balcony guarding height is used to increase safety

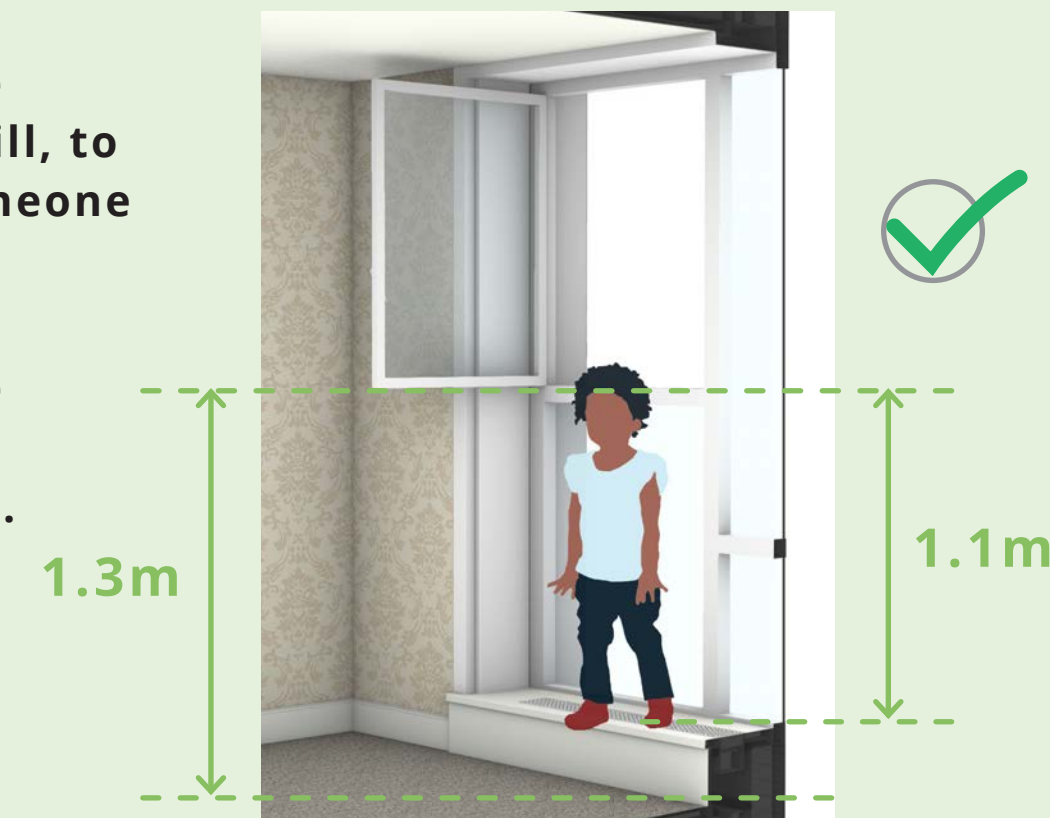

✓

The new guarding height means that even if someone stands on the window sill, there is the equivalent of a regulatory compliant balcony balustrade preventing the risk of fall through the open window.

*Note that the 90° opening setting is optional and has been provided for purge ventilation rather than normal ventilation. It is controlled with an additional key. See Pages 13 & 14 for Opening Settings.*

WHY CAN'T THE NEW WINDOWS OPEN OUTWARDS?

**WINDOWS OPEN INWARDS SO THEY CAN OPEN FURTHER, FOR BETTER VENTILATION**  
If we want the new windows to provide better ventilation, they need to open further than the existing windows (more than 30cm). It is not recommended to allow windows to open more than 30cm outwards because:

**A. RESIDENT'S SAFETY**

The CDM risk assessment (see Page 16) identified the risks of designing outward-opening windows that open more than 30cm, as this would encourage residents to lean out too far and therefore must be mitigated:



❌ Residents need to lean out of the window to open and close it



✅ Residents do not need to lean out of the window. An option will be given to open the window more than 30cm if residents choose to unlock this setting.

**B. SAFETY OF PUBLIC**



Façades of high-rise buildings are subject to high wind forces. There is a risk that open-out windows will act as a sail, catching the wind and exerting too much force on the opening mechanism. This was identified by the CDM risk assessments (see Page 16). In the past, windows have fallen off Chalcots buildings. Therefore, it is not recommended to install outward-opening windows as this poses a safety risk to the public.



# VENTILATION

## HOW IS THE PURGE VENTILATION CALCULATED?

### Building Regulations for replacing Chalcots windows

Approved Document F, Appendix B: Purge Ventilation

The new Chalcots windows need to perform at least as well as the existing windows, but according to the Building Regulations they do not need to meet the purge ventilation standards described below because the works are to existing buildings. However, due to the risk of overheating identified in the CDM risk register, we aimed to improve performance to meet regulatory standards (see Page 16).

**Rule 1: For openings of 15-30°**

**Rule 2: For openings more than 30°**

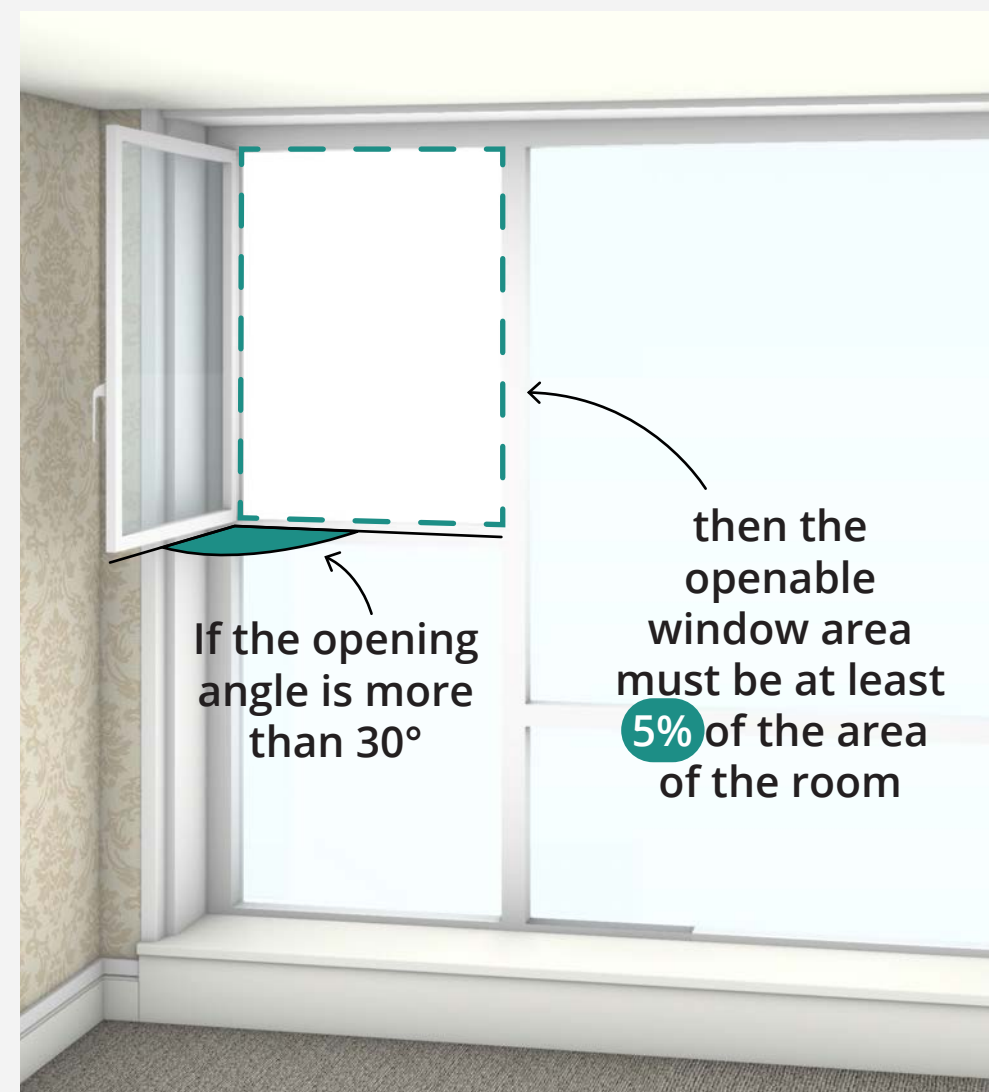
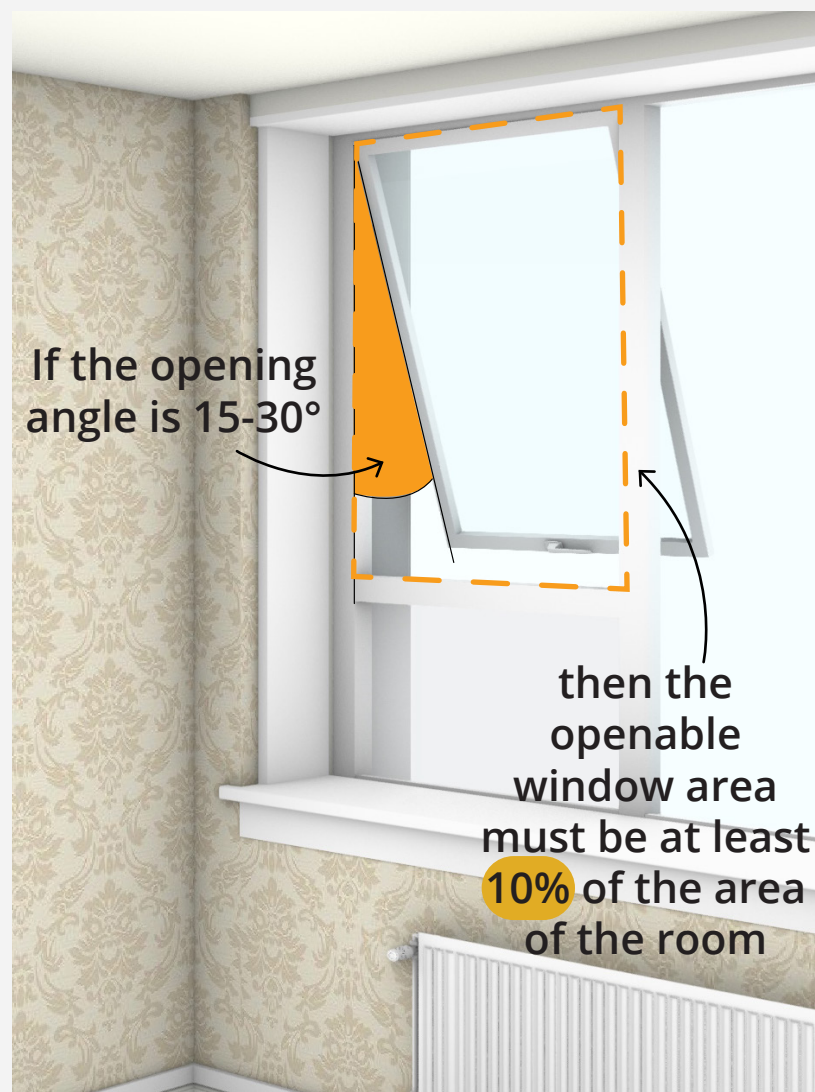

- The direction the window opens does not matter in the Approved Document
- Windows with opening angles below 15° are not suitable for purge ventilation
- If there are two windows in a room the total window area can be counted, but only the opening angle of the bigger window is considered
- Window reveals are not considered in these results. They are considered in overheating, see Page 27.



**Existing windows**  
**Opening setting: 30cm**

The existing windows open 30cm, which is approximately 22°.

Therefore the window opening area should be above 10% of the area of the room.

*For the results of the purge ventilation calculations please see the table on the following page*

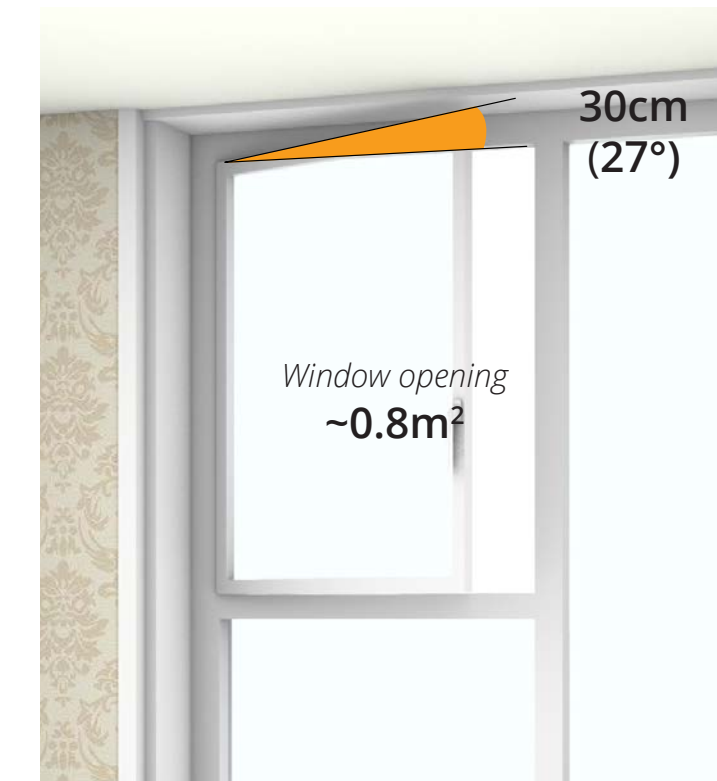

**New tilt & turn window**  
**Opening setting: 30cm**

The new bedroom and living room windows can open 30cm, which is approximately 27°.

At this setting, the window opening area should be above 10% of the area of the room. (see table on the next page)

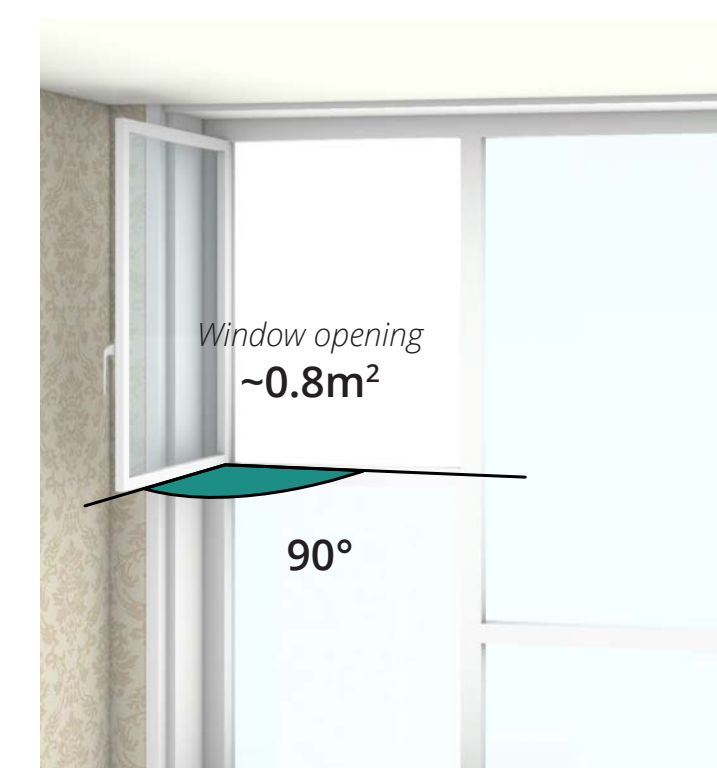

**New tilt & turn window:**  
**Opening setting: 90°**

The new bedroom and living room windows can open 90°.

At this setting, the window opening area should be above 5% of the area of the room.

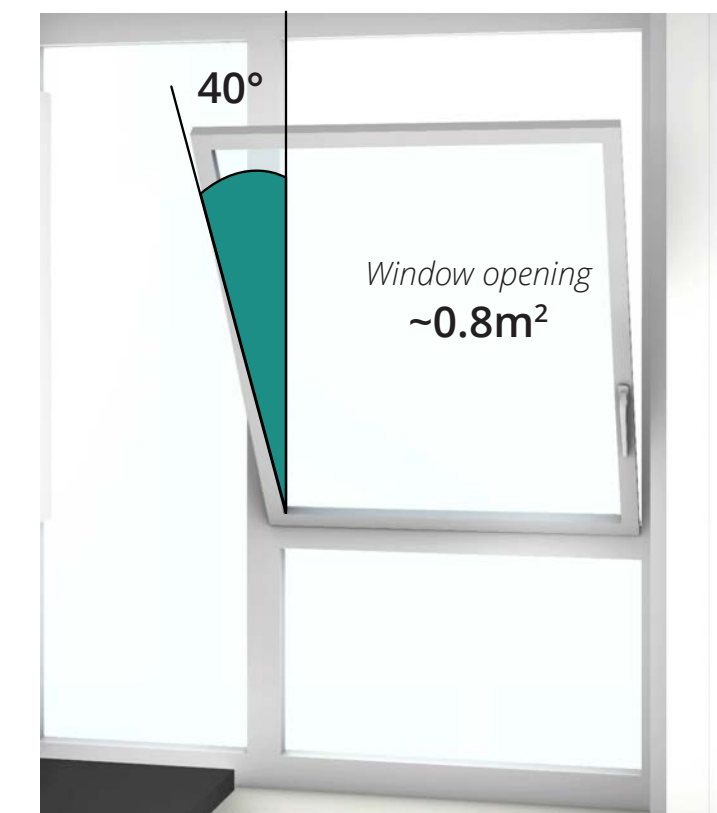

**New tilt-only window:**  
**Opening setting: 40°**

The new kitchen, bathroom and side windows in the lounge can open 40°.

The window opening area should be above 5% of the area of the room.



# VENTILATION

## DO THE NEW WINDOWS MEET CURRENT PURGE VENTILATION STANDARDS?

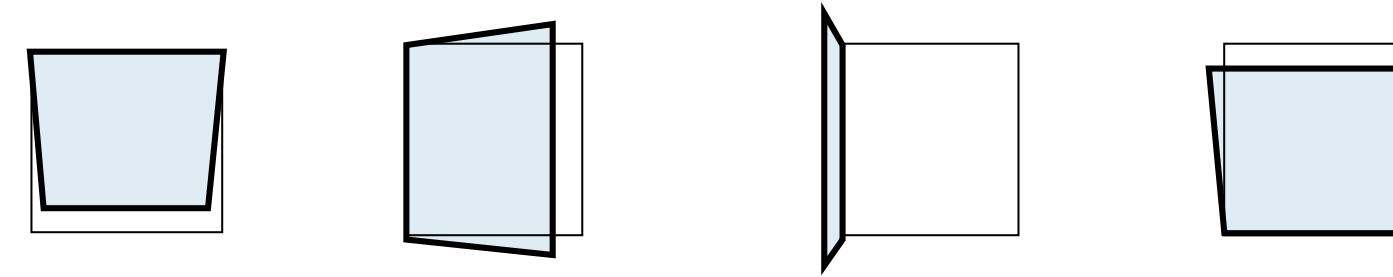

		Floor Area	Openable Window	Openable window area as % of floor area	Existing	New				
		sqm	sqm		30cm Tilt Out 10% required	30cm Turn In 10% required	90° Turn In 5% required	40° Tilt In 5% required		
Flat A	Bedroom	11.502	0.791025	7%	Fail	Fail	Pass	n/a		
	Bedroom	11.359	0.791025	7%				n/a		
	Bedroom	11.332	0.791025	7%				n/a		
	Kitchen	9.939	0.791025	8%				n/a	n/a	Pass
	Living Room	17.532	1.48255	8%				n/a		
Flat B	Bedroom	11.102	0.791025	7%	Fail	Fail	Pass	n/a		
	Bedroom	10.844	0.791025	7%				n/a		
	Bedroom	10.765	0.791025	7%				n/a		
	Kitchen	10.067	0.791025	8%				n/a	n/a	Pass
	Living Room	17.328	1.48255	9%				n/a		
Flat C	Bedroom	12.943	0.791025	6%	Fail	Fail	Pass	n/a		
	Bedroom	11.634	0.791025	7%				n/a		
	Kitchen	9.094	0.791025	9%				n/a	n/a	Pass
	Living Room	18.046	1.48255	8%				n/a		
Flat D	Bedroom	11.382	0.791025	7%	Fail	Fail	Pass	n/a		
	Bedroom	11.578	0.791025	7%				n/a		
	Kitchen	9.569	0.791025	8%				n/a	n/a	Pass
	Living Room	18.113	1.48255	8%				n/a		
Flat E	Studio	13.811	0.791025	6%	Fail	Fail	Pass	n/a		
	Kitchen	6.701	0.791025	12%				Pass	n/a	Pass
Flat F	Bedroom	11.644	0.791025	7%	Fail	Fail	Pass	n/a		
	Bedroom	10.557	0.791025	7%				n/a		
	Kitchen	10.218	0.791025	8%				n/a	n/a	Pass
	Living Room	18.673	1.48255	8%				n/a		
Flat G	Bedroom	12.427	0.791025	6%	Fail	Fail	Pass	n/a		
	Kitchen	8.146	0.791025	10%				Pass	n/a	Pass
	Living Room	18.304	1.48255	8%				Fail	n/a	Pass

### Conclusions:

As The Chalcots are existing buildings, there is a requirement to meet at least the existing performance, but the windows do not need to meet current Building Regulations (see Page 16). However, due to the risk of overheating identified as part of the CDM Regulations, we aimed to provide purge ventilation for residents.

Due to the fixed proportion between the opening window size and the room size, the new windows need to open more than 30° to meet current purge ventilation standards. Therefore, in their fully open position, new windows will meet the Building Regulation standards.

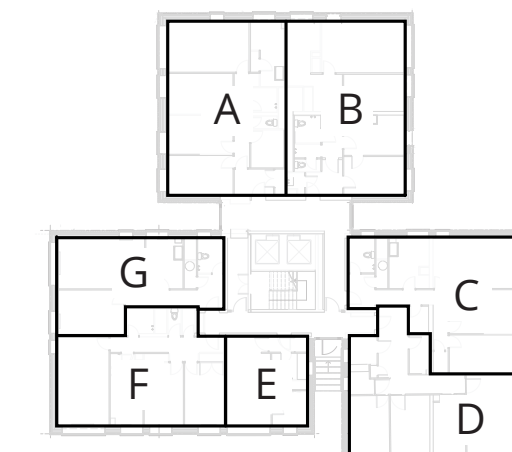

**Key**

- Pass
- Fail

## A CLOSER LOOK AT: TRICKLE VENTS

### WHY DO WE NEED TRICKLE VENTS IN THE WINDOWS?

Trickle vents allow moist air to escape, helping to prevent problems such as stale indoor air, condensation, mould and dew build-up on the glazing.

The new windows will have trickle vents installed in each window frame.

### EXAMPLE TRICKLE VENTS:

Trickle vents will be designed to allow enough ventilation for the size of the room. Requirements for the minimum free area of trickle vents has increased since the existing windows were installed. New windows will meet current regulations.

Below are some examples of trickle vents:



*Example 1: Shueco trickle vent*



*Example 2: Titon trickle vent*

### WHAT ARE TRICKLE VENTS?

Trickle vents are the most common type of background ventilators.

They are small openings embedded in the window frames.

They allow humid air to escape when the windows are shut.

Most trickle vents can be manually opened or closed.

### HOW DO TRICKLE VENTS AFFECT RESIDENTS?

Trickle vents mean you can leave your windows closed without worrying about stagnant air inside the flat.

The trickle vent will be part of the window frame, it allows for low level ventilation while keeping noise pollution and rain out.



**OVERHEATING & VENTILATION  
HOW HAVE THE OVERHEATING & ENERGY CONSERVATION  
IMPROVEMENTS BEEN ACHIEVED?**

Reducing overheating:

Lowering energy consumption:

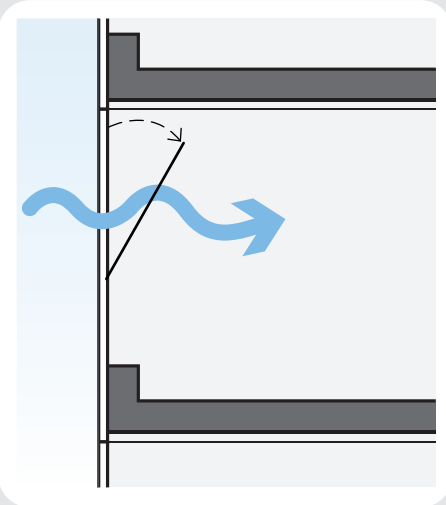
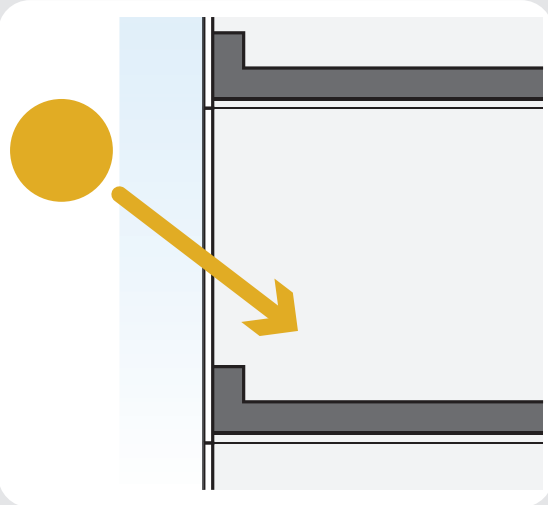
	 <p><b>PURGE VENTILATION</b> Natural ventilation when windows are open</p>	 <p><b>G-VALUE</b> How much of the sun's heat is transmitted through the glass.</p>
<b>EXISTING WINDOWS</b>	Not meeting current Building Regulations for purge venting	0.59
<b>NEW WINDOWS</b>	Meeting current Building Regulations for purge venting	0.33

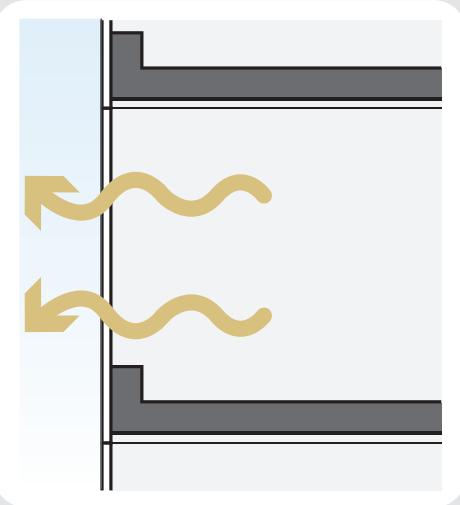
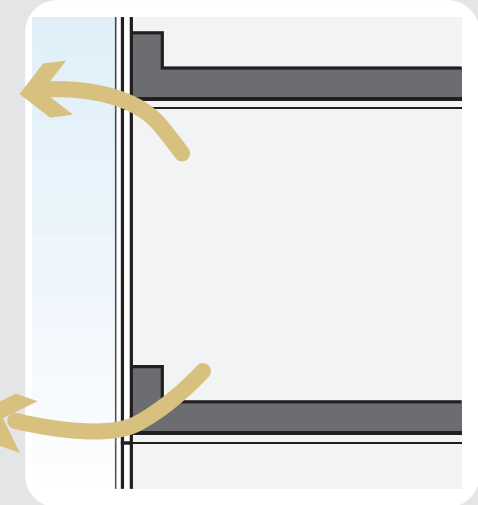
	 <p><b>U-VALUE</b> The rate that heat is transferred through a wall/window material. W/m<sup>2</sup>k</p>	 <p><b>AIR TIGHTNESS</b> How well the walls and windows are sealed to reduce air leakage. m<sup>3</sup>/h/m<sup>2</sup> @ 50Pa</p>
	1.9 - 2.4	10
	1.6	5

*The lower the value, the better the performance*

*The lower the value, the better the performance*

*The lower the value, the better the performance*

The new windows can open further than the existing windows to provide improved ventilation that complies with current standards for purge ventilation

The new glass will include a high performance solar control coating so it has a lower G-Value than the existing windows and the amount of solar gain is reduced

The new glass will be double glazed and it has a lower U-Value so the windows are better insulated

The new cladding and windows will be more airtight, so less warm air can escape during winter

KEY CONSIDERATIONS FOR OVERHEATING CALCULATIONS

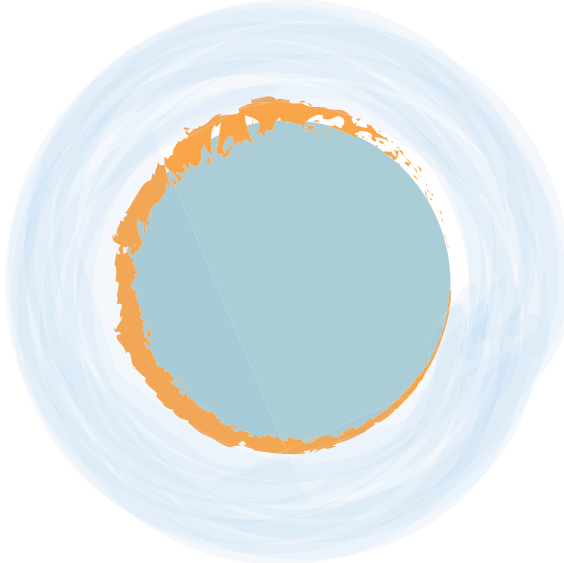

GLOBAL WARMING

Standardised weather files are used to predict hot summers in line with climate change data

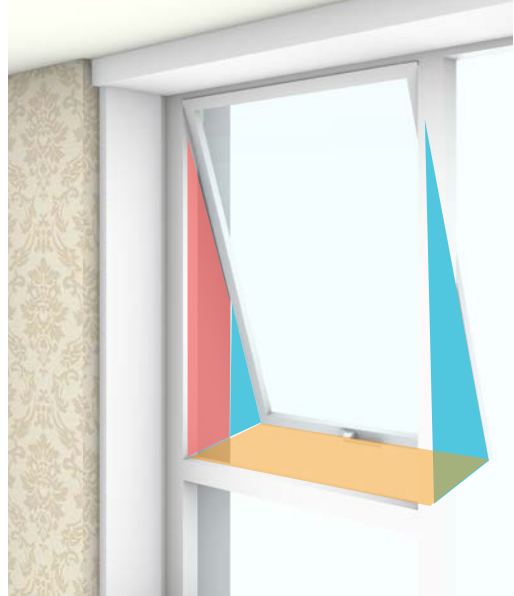

WINDOW REVEALS

Accounting for reduced air flow due to window reveals



CLOSED WINDOWS

As defined in CIBSE TM59, windows are assumed to be closed until the temperature reaches 22°C

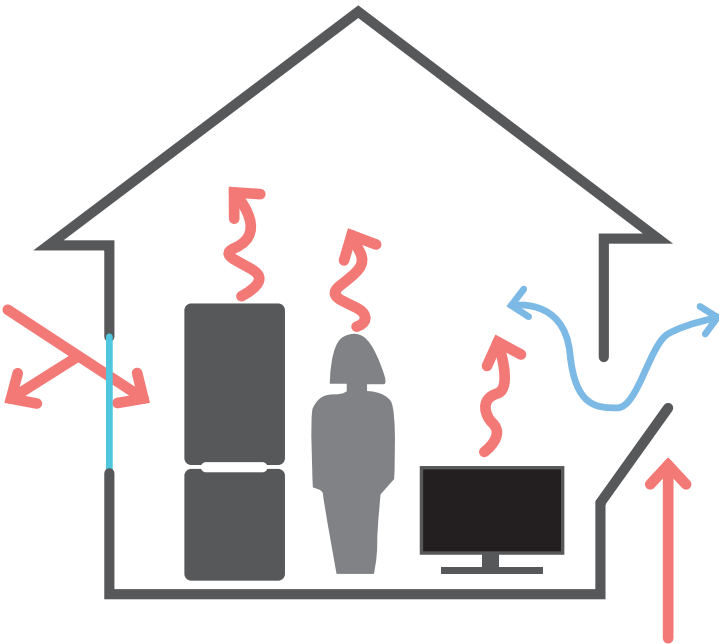

PEOPLE, LIGHTS, EQUIPMENT

People, appliances and lighting can all generate heat. These have been modelled and taken into account as per TM59 Load Summary

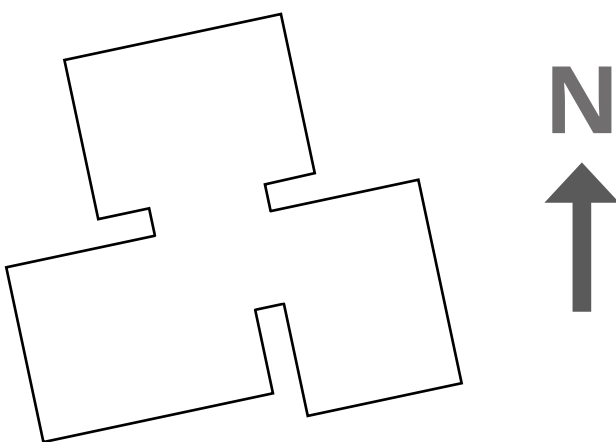

ORIENTATION

The direction the towers are facing has been taken into account for each window



CURTAINS / BLINDS

The worst case scenario is assumed where blinds/curtains are left open and provide no benefit

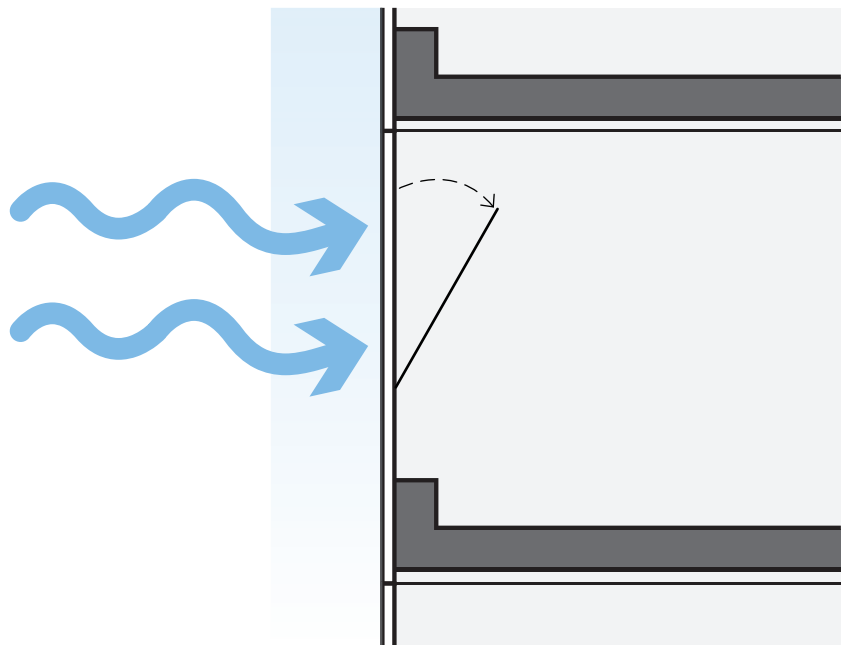

WIND

A conservative assumption is used where external air speed is very low (0.1m/s) and no other means to generate air movement is available

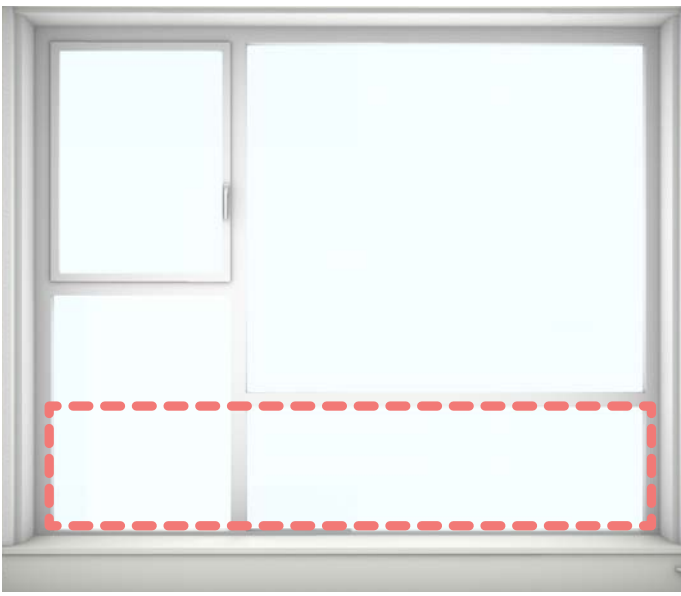

LARGER WINDOWS

The overheating analysis takes into account the whole window not only the opening part. This includes the new glazed panel.

### WHY USE TM59?

We carried out the TM59 analysis on Chalcots to make sure the new windows improve summertime overheating issues and to future proof the window design against updates to the Building Regulations.

The CIBSE TM59 analysis is the latest industry standard method used to assess overheating in buildings.

Currently overheating analysis is not mandatory for new residential buildings. **According to the regulations relating to overheating, the new windows only have to meet the same standard as the existing windows. However, Camden is committed to providing substantial improvement given the residents feedback on overheating, the risk of overheating identified under CDM regulations (described on Page 16) and to future proof the buildings.**

To improve standards, the government is in the process of updating the Building Regulations methodologies to include requirements for TM59 analysis. However, the current new updates will only require new buildings to comply with TM59.

These changes have not yet taken effect, so there is still no legal requirement to comply with TM59.

By carrying out TM59 analysis, we have exceeded the current and new government requirements for overheating analysis.

### IS TM59 A FUTURE PROOF METHOD?

A new 'Approved Document' (a document that demonstrates how to comply with the Building Regulations) focussing on overheating is currently being reviewed by the government. The draft version shows that the government plans to introduce CIBSE TM59 as a requirement for all new residential buildings.

During the consultation period for the government's new Approved Document, Arup commented that requirements for TM59 analysis should be extended to include existing residential buildings, not just new-builds.

If this comment is taken on board and the government does raise overheating standards for work to existing buildings, Chalcots will have already fulfilled the requirement to carry out TM59 analysis. The new windows have been designed so that most rooms already comply with TM59.

It is important to understand how the new window design will perform in an overheating scenario to ensure there is an improvement in performance. At Chalcots, conducting this dynamic modelling has proved that the new design will reduce the risk of overheating when compared to the existing windows.

### WHAT ABOUT CLIMATE CHANGE?

The Chalcots windows have been tested using two different weather data files:

- London DSY1 2020 High50, which covers 2011 - 2040
- London DSY1 2050 High50, which covers 2041 - 2070

The future weather files are made by projecting data based on a previous year onto the future, to account for climate change impacts. The files are created by CIBSE (Chartered Institute of Building Services Engineers), who work with technical specialists across the country to develop standards and give guidance to improve building performance: [www.cibse.org](http://www.cibse.org).

There are three main components to a future weather data file:

1. Weather data based on a year in the past is used as a baseline from which to represent future weather. The baseline data used for the Chalcots analysis is called 'Design Summer Year 1' (DSY1). DSY1 is similar to the UK 1989 summer which consisted of a 'moderately warm summer'.
2. To account for the impacts of climate change, the DSY1 data in the weather file is 'uplifted' to incorporate the predicted UKCIP09 climate change scenarios. CIBSE produce a weather file for the 2011-2040 and the 2041-2070 time periods using a 'high emission scenario' which is what has been used in the overheating assessments.
3. The severity of the impact of the high greenhouse gas emissions is then broken down into percentiles. For both the 2011-2040 analysis and the 2041-2070 analysis carried out on Chalcots, the 50th percentile was used, which is a median level of impact of a high emissions, high climate change scenario.

# OVERHEATING ANALYSIS CIBSE TM59

## THE ASSESSMENT CRITERIA

CIBSE TM59 sets out a method for assessing overheating risk in residential buildings. Overheating risk is assessed by two criteria:

### CRITERION A

ALL ROOMS EXCEPT BATHROOMS / STORAGE

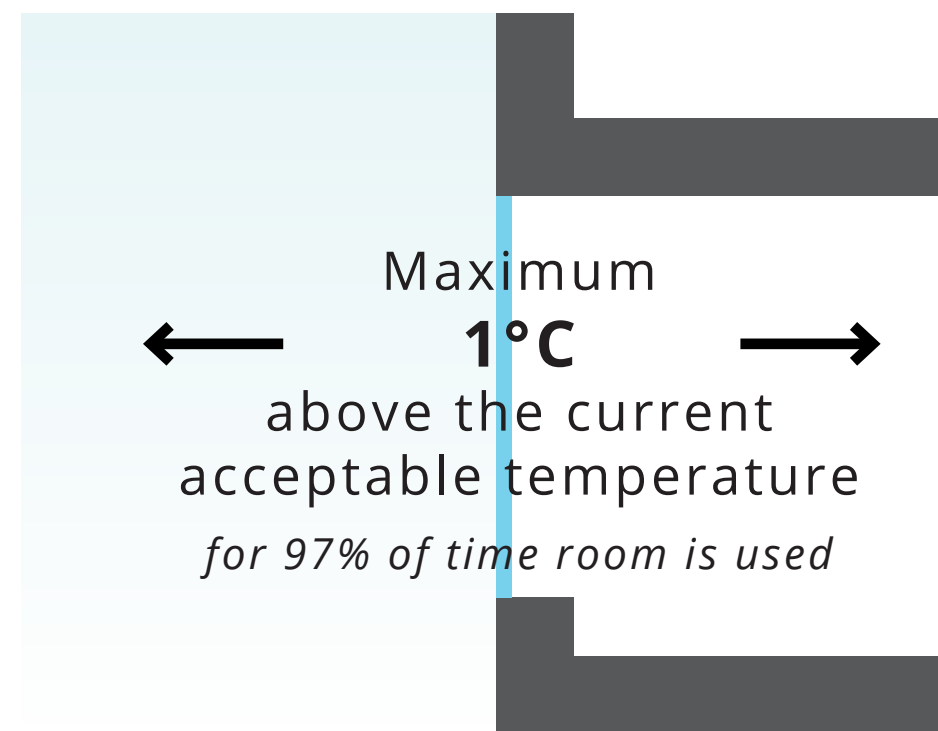

Between May and September, the operative temperature in occupied rooms shall not exceed the maximum acceptable temperature by more than 1°C for more than 3% of occupied hours.

The maximum acceptable temperature is related to the average outdoor temperature across a number of days. Criterion A is designed to prevent sudden spikes in indoor temperature.

### CRITERION B

BEDROOMS

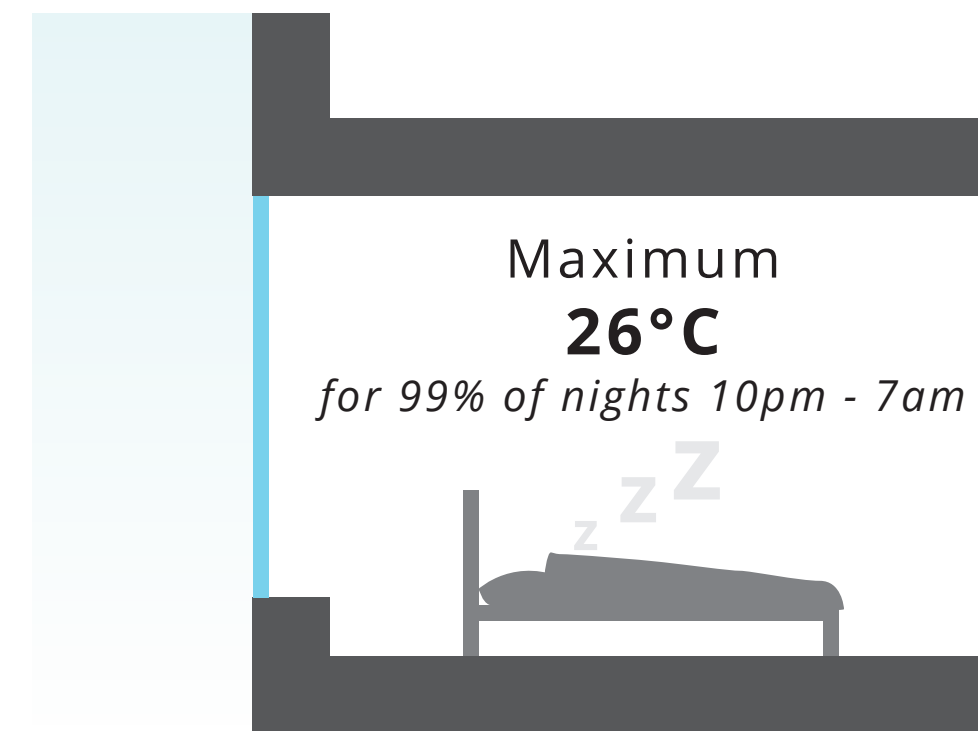

From 10pm - 7am, the temperature should not exceed 26°C for more than 1% of annual hours (less than 33 hours). This provides a level of comfort during typical sleeping hours.

### More about Criterion B:

The 26°C fixed temperature test (Criterion B) is often found to be difficult to comply with, particularly using London weather data. The robustness of this as a measure of comfort in bedrooms is questionable.

The UK governments supporting research to the Future Homes Standard Consultation highlighted that the science behind this value is not as robust as it could be. The correct value is likely to be somewhere between 26°C and 29°C and it may also be more closely related to the average outdoor temperature as in Criterion A.

Recent work by the UK government has shown that reported overheating does not correlate well with the 26°C threshold and that it is likely to be overly onerous. Academic research is underway to review this and updates may be made to this criterion in the future.

# OVERHEATING ANALYSIS CIBSE TM59

## IS THE ANALYSIS CARRIED OUT ON A VIRTUAL MODEL?

Virtual models have to be used to evaluate overheating as it would not be possible to realistically test all weather scenarios and conditions required to give a complete picture across the year in an actual flat. Individual configurations and furnishings in flats cannot be taken into account because each flat would have to be modelled separately and evaluated across the year.

Early overheating analysis of all towers showed that Blashford was at a lower risk of overheating due to larger room sizes so the calculations presented below focus on Bray, Burnham, Dorney & Taplow towers.



A dynamic thermal simulation model has been created using the industry standard software Integrated Environment Solutions Virtual Environment (IES VE 2021).

*Screenshot of the model*

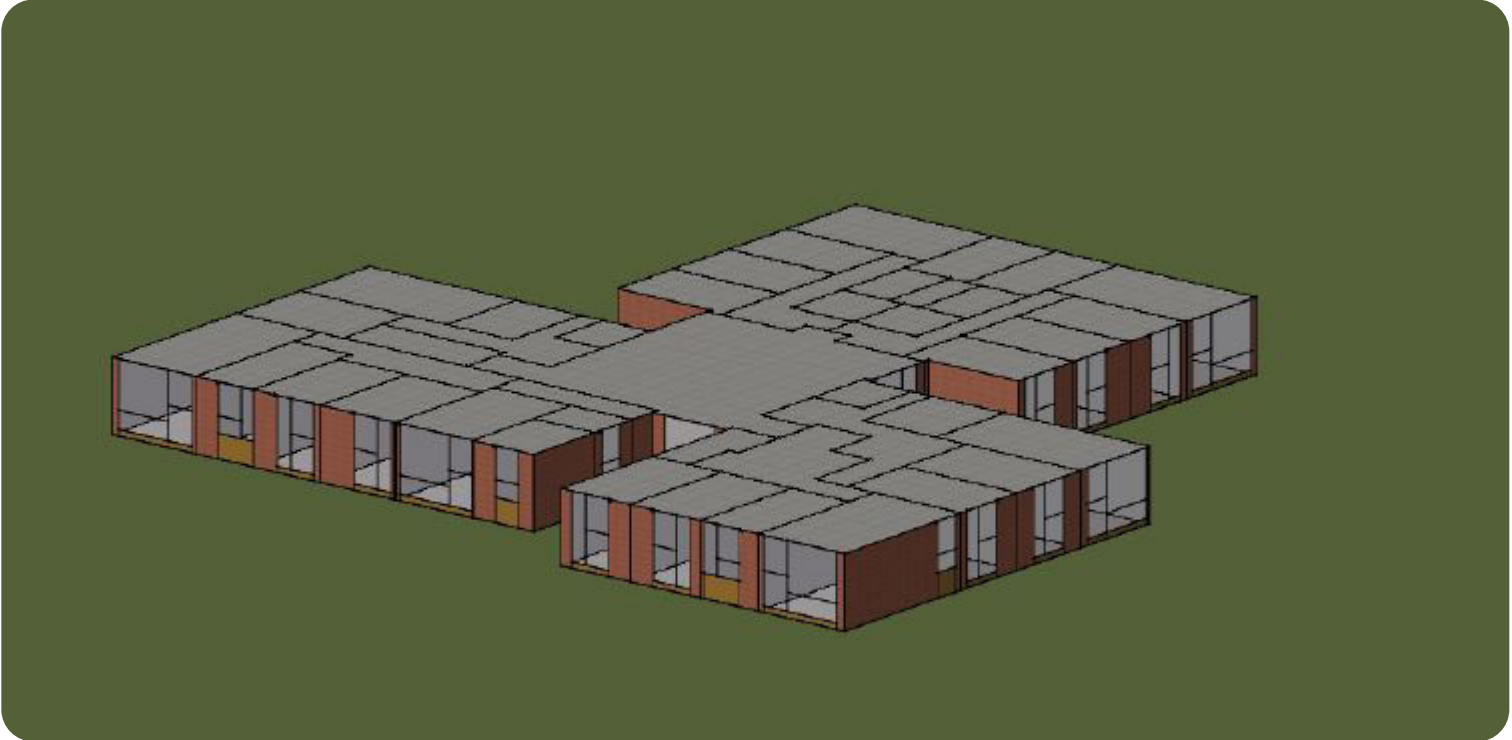

The building plan and arrangement of flats on each floor is generally repetitive, meaning analysis can be carried out for one typical floor to adequately represent all flats, facade orientations and degrees of solar exposure. A typical floor of Burnham has been used for these analysis.

*Screenshot of the model*

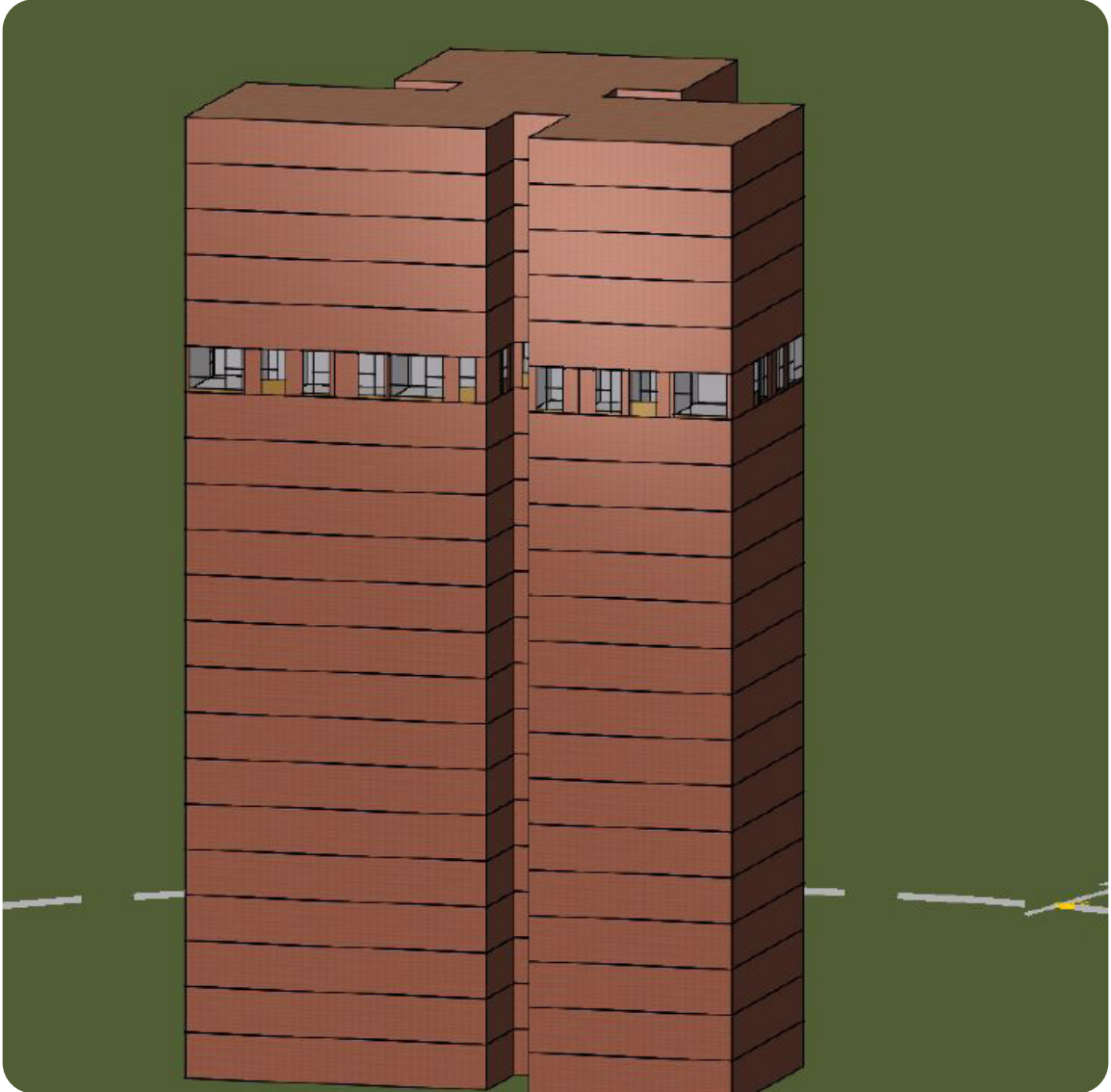

Standards for each room were assigned based on the type of room, occupancy, internal gains (the heat generated from people, lights and equipment), as per CIBSE TM59 guidance.







ARE THE WINDOW REVEALS TAKEN INTO ACCOUNT WHEN CALCULATING OVERHEATING?

STANDARD METHOD FOR CALCULATING AIR FLOW:

Window reveals restrict the free area for air to flow through windows.

The existing windows have external reveals of 15cm. The new windows will have internal reveals of 30cm.

The air flow restriction due to reveals are taken into account in the calculations

-   } The sum of these areas is the **free area** used in the assessment
-  Limited air flow, disregarded from calculations
-  Area of the operable window



If the sum of the free area is equivalent or greater than the area of the operable window, the area of the operable is used instead, as per the standard methodology which was developed by the American Society of Heating, Refrigerating and Air-Conditioning Engineers

EXISTING  
Tilt-out window next to one reveal

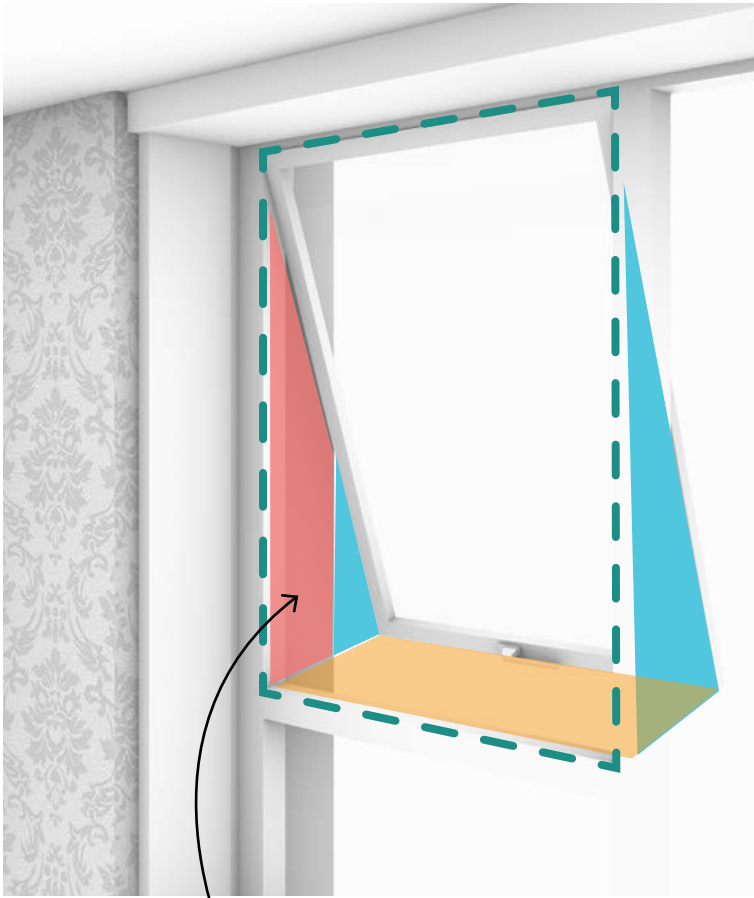

Airflow is obstructed on at least one side by the facade



NEW  
Tilt & Turn window next to one reveal

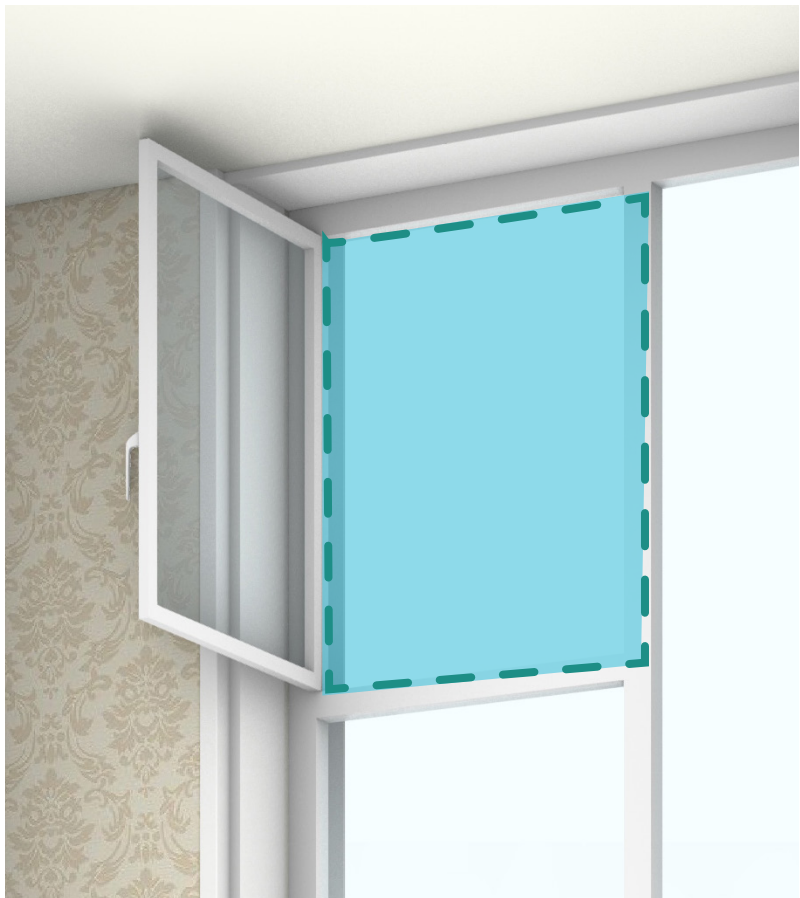

Minimal obstructions to airflow / full window area is used

NEW  
Tilt-in window next to one reveal

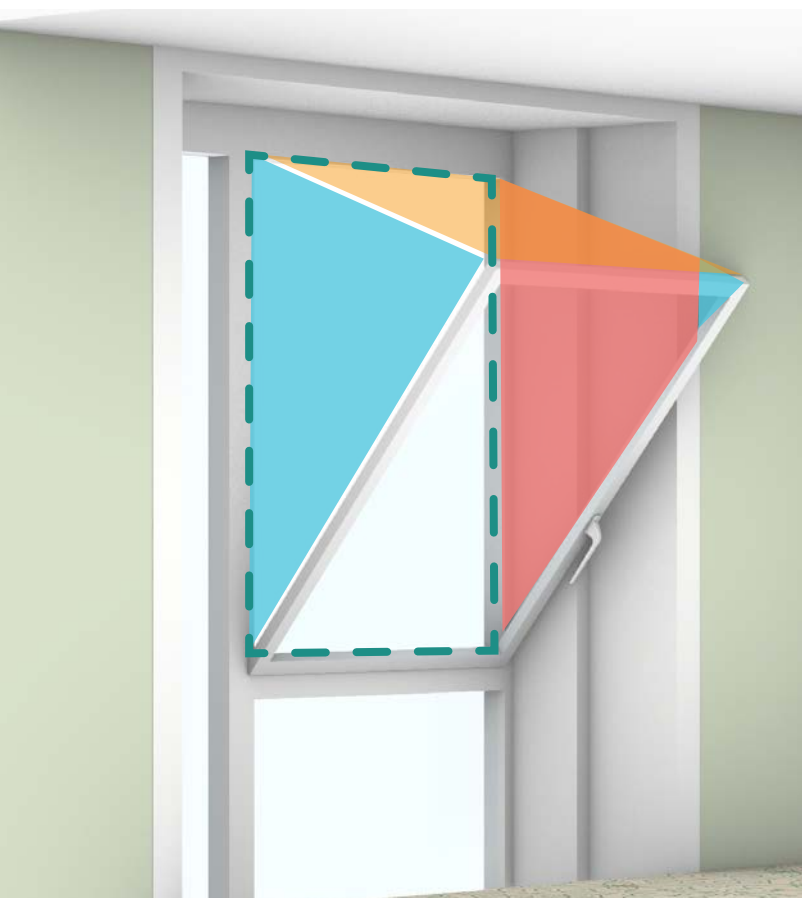

Airflow is obstructed on one side by the reveal

The assumption for air flow is a conservative estimate because we have not accounted for any air flow in the red zones. In reality some air is likely to be able to move between these gaps and the results would likely be better than shown.





**DO THE NEW WINDOWS MEET BUILDING REGULATIONS?**

Yes. The testing has been carried out to ensure the new windows perform better than the existing windows. The windows do not need to pass the CIBSE TM59 test as this is not a requirement under the Building Regulations.

**All new windows perform better than the existing windows.**

**WILL THIS SCENARIO DEFINITELY HAPPEN?**

This analysis is based on predicted temperatures that may or may not occur. There is approximately a 1-in-7 chance of future summers being equal or hotter than the baseline summer temperatures used (the DSY1 file). A 'high emissions' scenario is used to predict climate change. See Page 30.

**WHAT DIFFERENCE WILL THE NEW WINDOWS MAKE?**

If this scenario occurs, the new windows provide approximately **55% improvement** for rooms within the existing towers and greatly reduce the likelihood of overheating.

For more information refer to Page 30.

		Existing 30cm Tilt Out	30cm Turn In	New 90° Turn In	40° Tilt In
Flat A	Bedroom	4.0%	1.5%	1.5%	n/a
	Bedroom	5.2%	1.9%	1.9%	n/a
	Bedroom	5.7%	2.3%	2.2%	n/a
	Kitchen	4.7%	n/a	n/a	1.4%
	Living Room	9.5%	5.8%	4.2%	n/a
Flat B	Bedroom	1.2%	0.8%	0.8%	n/a
	Bedroom	1.6%	0.9%	0.9%	n/a
	Bedroom	1.9%	0.9%	0.9%	n/a
	Kitchen	4.2%	n/a	n/a	1.4%
	Living Room	4.1%	2.7%	2.4%	n/a
Flat C	Bedroom	1.7%	0.9%	0.9%	n/a
	Bedroom	1.8%	0.9%	0.9%	n/a
	Kitchen	1.5%	n/a	n/a	1.3%
	Living Room	3.5%	2.7%	2.2%	n/a
Flat D	Bedroom	4.2%	1.1%	1.1%	n/a
	Bedroom	4.0%	1.2%	1.2%	n/a
	Kitchen	10.5%	n/a	n/a	1.6%
	Living Room	6.5%	3.0%	2.5%	n/a
Flat E	Studio	11.3%	3.6%	3.5%	n/a
	Kitchen	7.6%	n/a	n/a	2.0%
Flat F	Bedroom	4.9%	1.4%	1.4%	n/a
	Bedroom	4.9%	1.2%	1.2%	n/a
	Kitchen	10.2%	n/a	n/a	1.6%
	Living Room	9.1%	3.8%	2.7%	n/a
Flat G	Bedroom	5.0%	1.7%	1.6%	n/a
	Kitchen	2.7%	n/a	n/a	1.4%
	Living Room	7.6%	4.7%	3.2%	n/a

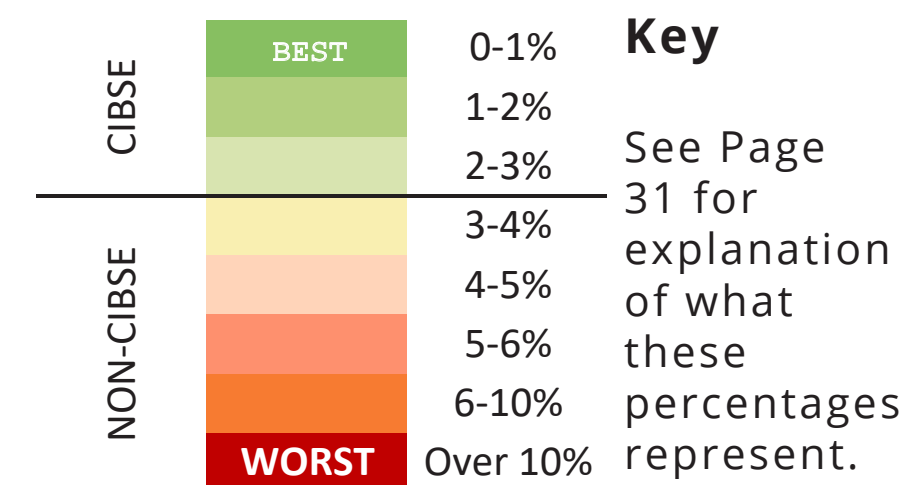
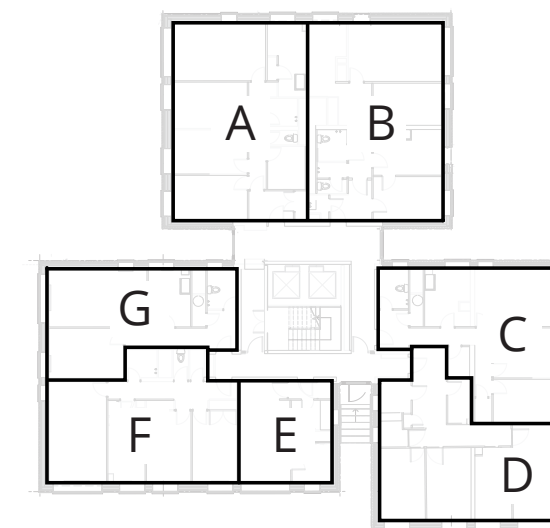



**DO THE NEW WINDOWS MEET BUILDING REGULATIONS?**

Yes. The testing has been carried out to ensure the new windows perform better than the existing windows. The windows do not need to pass the CIBSE TM59 test as this is not a requirement under the Building Regulations.

**All new windows perform better than the existing windows.**

**WILL THIS SCENARIO DEFINITELY HAPPEN?**

These results predict how the windows perform during summer weather in 2041-2070, based on predicted future weather in which there has been high carbon emissions and a greater chance of extreme weather.

**WHAT DIFFERENCE WILL THE NEW WINDOWS MAKE?**

If this scenario occurs, the new windows provide approximately **60% improvement** for rooms within the existing towers and greatly reduce the likelihood of overheating.

For more information refer to Page 30.

		Existing 30cm Tilt Out	30cm Turn In	New 90° Turn In	40° Tilt In
Flat A	Bedroom	6.4%	3.0%	3.0%	n/a
	Bedroom	7.3%	3.6%	3.6%	n/a
	Bedroom	7.7%	3.7%	3.6%	n/a
	Kitchen	8.2%	n/a	n/a	2.8%
	Living Room	14.0%	9.2%	7.2%	n/a
Flat B	Bedroom	2.4%	1.4%	1.4%	n/a
	Bedroom	3.2%	1.8%	1.8%	n/a
	Bedroom	4.2%	2.0%	1.9%	n/a
	Kitchen	7.8%	n/a	n/a	2.8%
	Living Room	8.6%	5.6%	4.7%	n/a
Flat C	Bedroom	3.1%	1.8%	1.7%	n/a
	Bedroom	3.8%	1.8%	1.7%	n/a
	Kitchen	3.3%	n/a	n/a	2.0%
	Living Room	7.0%	5.0%	4.4%	n/a
Flat D	Bedroom	7.0%	2.4%	2.4%	n/a
	Bedroom	6.5%	2.4%	2.4%	n/a
	Kitchen	15.7%	n/a	n/a	3.4%
	Living Room	11.9%	6.0%	5.2%	n/a
Flat E	Studio	12.7%	6.1%	6.0%	n/a
	Kitchen	12.4%	n/a	n/a	5.3%
Flat F	Bedroom	7.6%	2.7%	2.7%	n/a
	Bedroom	7.7%	2.7%	2.7%	n/a
	Kitchen	14.5%	n/a	n/a	3.3%
	Living Room	13.1%	7.8%	5.8%	n/a
Flat G	Bedroom	7.1%	3.3%	3.3%	n/a
	Kitchen	4.5%	n/a	n/a	2.1%
	Living Room	11.5%	7.7%	6.4%	n/a

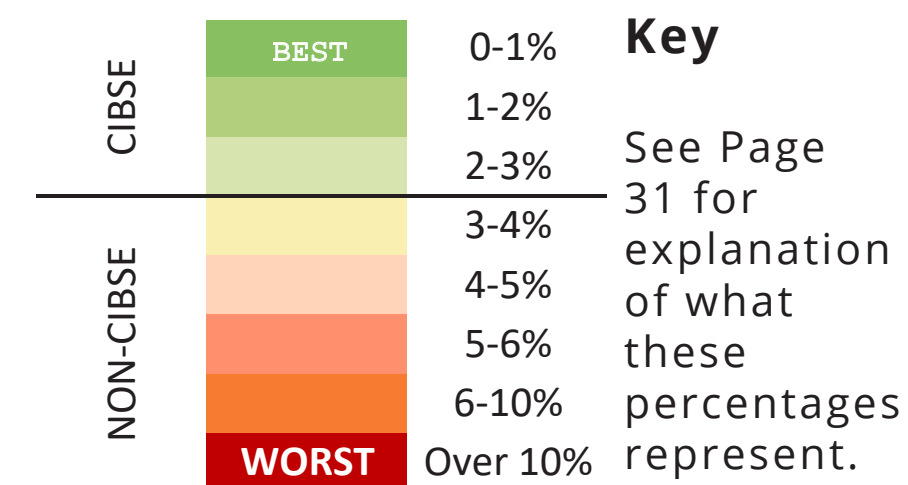
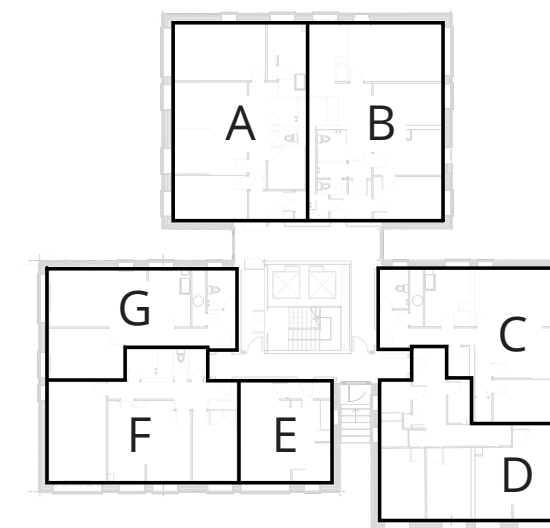

**OVERHEATING RESULTS: CRITERION B / 2011 - 2040**

**DO THE NEW WINDOWS MEET BUILDING REGULATIONS?**

Yes. The testing has been carried out to ensure the new windows perform better than the existing windows. The windows do not need to pass the CIBSE TM59 test as this is not a requirement under the Building Regulations.

**All new windows perform better than the existing windows.**

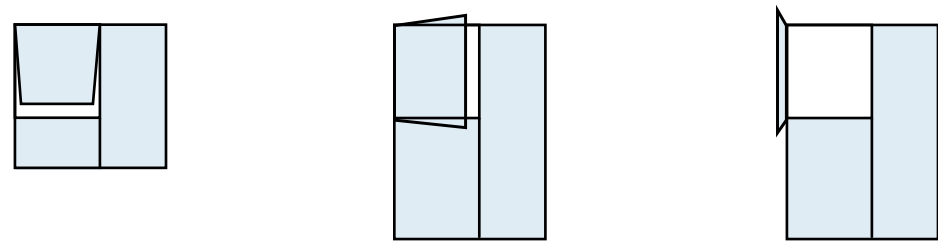

**WILL THIS SCENARIO DEFINITELY HAPPEN?**

This analysis is based on predicted temperatures that may or may not occur. There is approximately a 1-in-7 chance of future summers being equal or hotter than the baseline summer temperatures used (the DSY1 file). A 'high emissions' scenario is used to predict climate change. See Page 30.

**WHAT DIFFERENCE WILL THE NEW WINDOWS MAKE?**

If this scenario occurs, the new windows provide approximately **55% improvement** for rooms within the existing towers and greatly reduce the likelihood of overheating.

*For more information refer to Page 30.*

		Existing 30cm Tilt Out	New 30cm Turn In      90° Turn In	
Flat A	Bedroom	61	28	28
	Bedroom	61	28	28
	Bedroom	66	29	29
Flat B	Bedroom	45	22	22
	Bedroom	48	23	23
	Bedroom	55	27	26
Flat C	Bedroom	55	27	25
	Bedroom	53	24	24
Flat D	Bedroom	62	24	24
	Bedroom	61	26	26
Flat E	Studio	106	41	40
Flat F	Bedroom	63	25	25
	Bedroom	62	23	23
Flat G	Bedroom	62	29	28

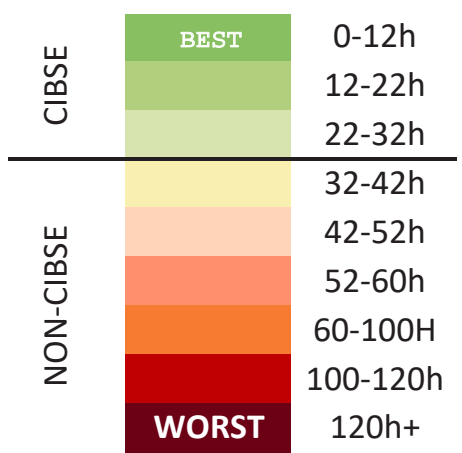
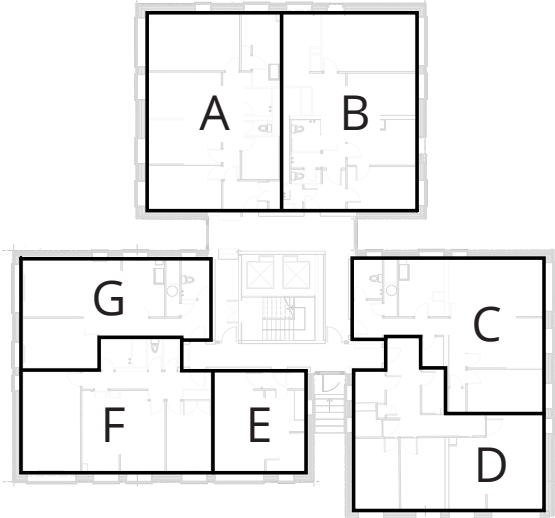

**Key**  
See Page 31 for explanation of what the hours represent.

**OVERHEATING RESULTS: CRITERION B / 2041 - 2070**

**DO THE NEW WINDOWS MEET BUILDING REGULATIONS?**

Yes. The testing has been carried out to ensure the new windows perform better than the existing windows. The windows do not need to pass the CIBSE TM59 test as this is not a requirement under the Building Regulations.

**All new windows perform better than the existing windows.**

**WILL THIS SCENARIO DEFINITELY HAPPEN?**

These results predict how the windows perform during summer weather in 2041-2070, based on predicted future weather in which there has been high carbon emissions and a greater chance of extreme weather.

The science behind the 26° criteria is under review (see Page 31) and it is very common for bedrooms not to comply when tested against 2041-2070 weather data.

**WHAT DIFFERENCE WILL THE NEW WINDOWS MAKE?**

If this scenario occurs, the new windows provide approximately **45% improvement** for rooms within the existing towers and greatly reduce the likelihood of overheating.

*For more information refer to Page 30.*

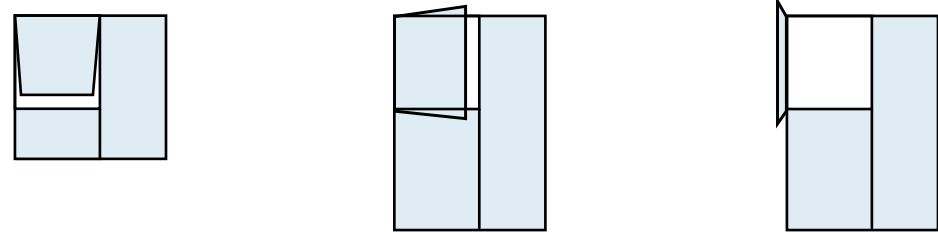

		Existing 30cm Tilt Out	New 30cm Turn In      90° Turn In	
Flat A	Bedroom	123	68	68
	Bedroom	124	67	67
	Bedroom	132	71	70
Flat B	Bedroom	100	59	59
	Bedroom	107	63	63
	Bedroom	117	68	66
Flat C	Bedroom	112	65	63
	Bedroom	110	64	60
Flat D	Bedroom	126	61	61
	Bedroom	125	70	70
Flat E	Studio	153	88	87
Flat F	Bedroom	126	68	68
	Bedroom	127	62	62
Flat G	Bedroom	127	70	66

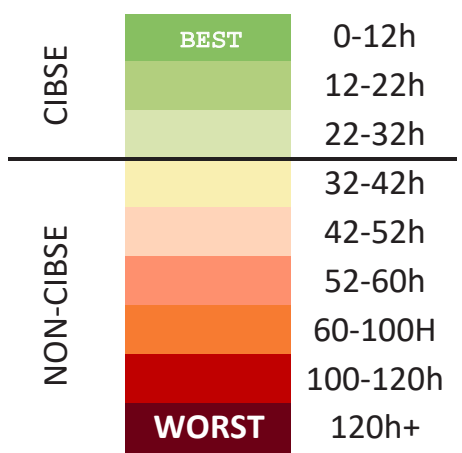
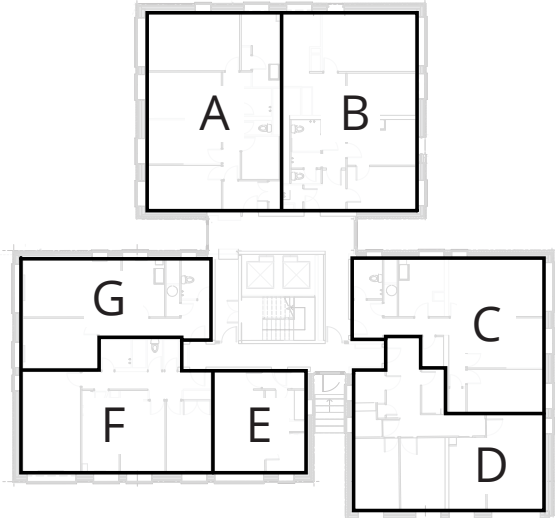

**Key**  
See Page 31 for explanation of what the hours represent.

# OVERHEATING

## ADVICE ON HOW TO KEEP YOUR FLAT COOL IN HOT WEATHER

### IF YOU ARE **GOING OUT**

If you are leaving your home on a hot day, it's best to prevent solar gain by closing blinds/curtains. There are two options:



#### OPTION 1

Keep your windows and blinds/curtains closed

If you are leaving your home, the simplest way to limit the internal temperature during hot periods is to keep your windows and blinds/curtains closed. This works if it's hotter outside than inside.

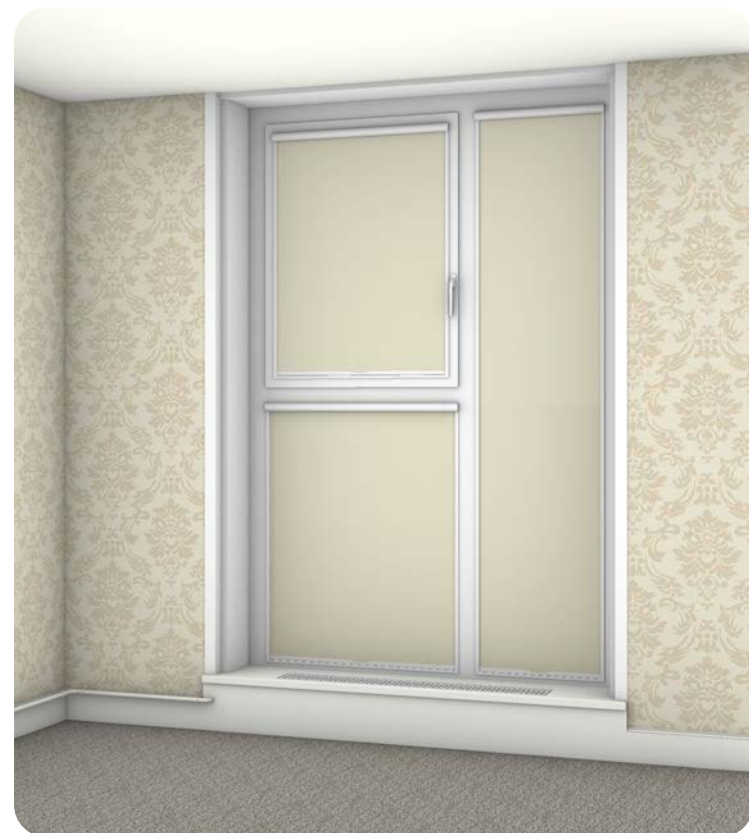
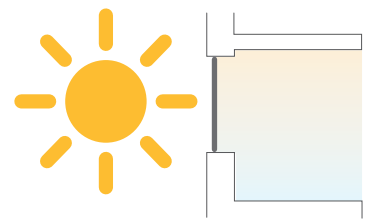

Illustrative example: bedroom with blind in window reveal



#### OPTION 2

Open your window 10cm and keep blinds/curtains closed

If it's hotter inside than it is outside, this option would allow some ventilation while preventing much solar gain.

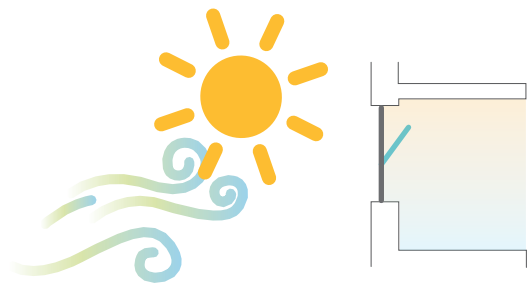

Illustrative example: bedroom with blind in window reveal

### IF YOU ARE **AT HOME**

If you are in your home, there are various options to keep cooler, depending on individual preference:



#### OPTION 1

Keep your windows and blinds/curtains closed

This option is especially relevant if it is warmer outside than in, as it prevents solar gain and convective heat transfer.

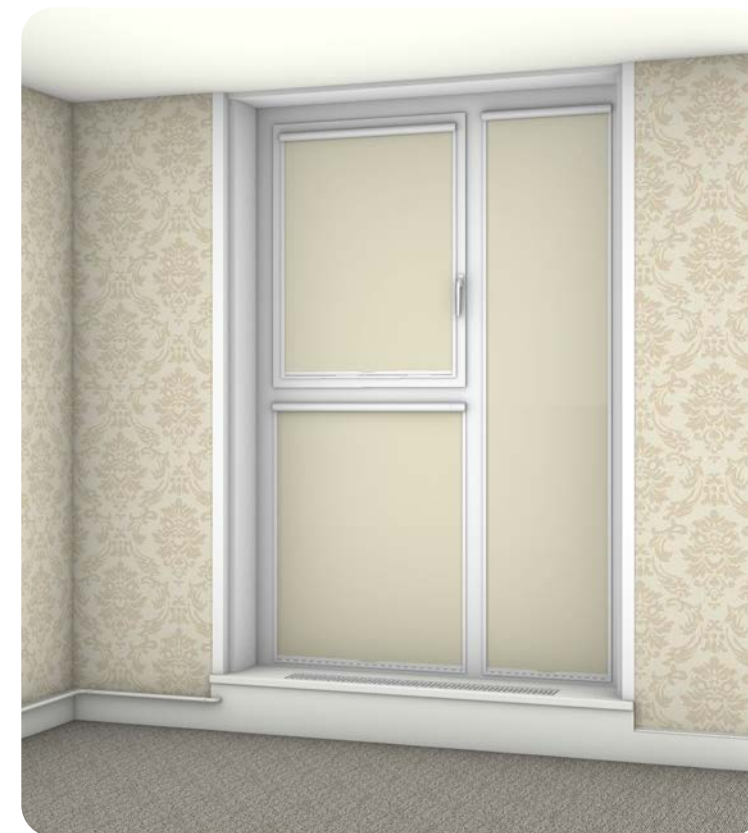
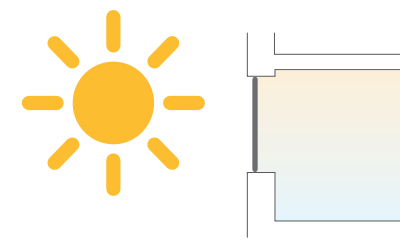

Illustrative example: bedroom with blind in window reveal



#### OPTION 2

Open your windows and keep you blinds/curtains closed as much as possible

This prevents much solar gain but allows for some air movement which could increase the internal air temperature if it's hotter outside. However it may be more comfortable for the residents if there's a breeze.

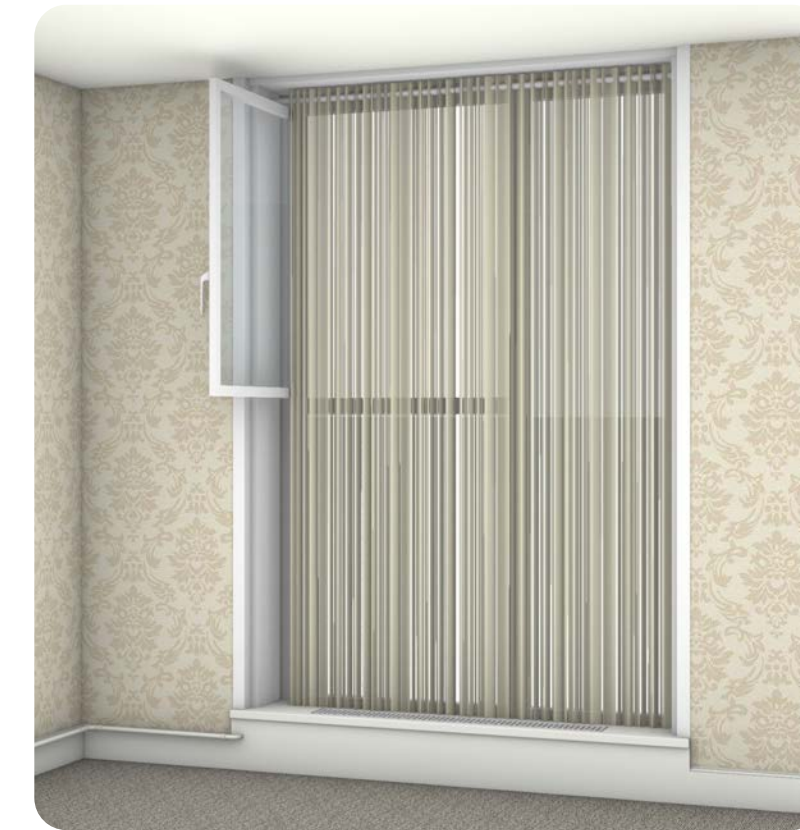
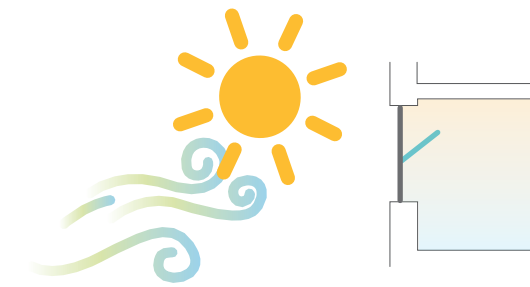

Illustrative example: bedroom with curtain in window reveal



#### OPTION 3

Open your windows and open your blinds/curtains

This encourages air movement and can purge the air within the home, which is beneficial especially when it is warmer inside than outside.

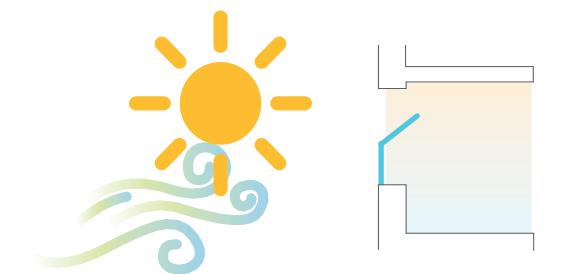

Illustrative example: lounge with wall-mounted curtain



# NEW WINDOWS

## ACCESSIBLE WINDOW OPERATION

### Regulations for adaptable dwellings

**Window control location:**

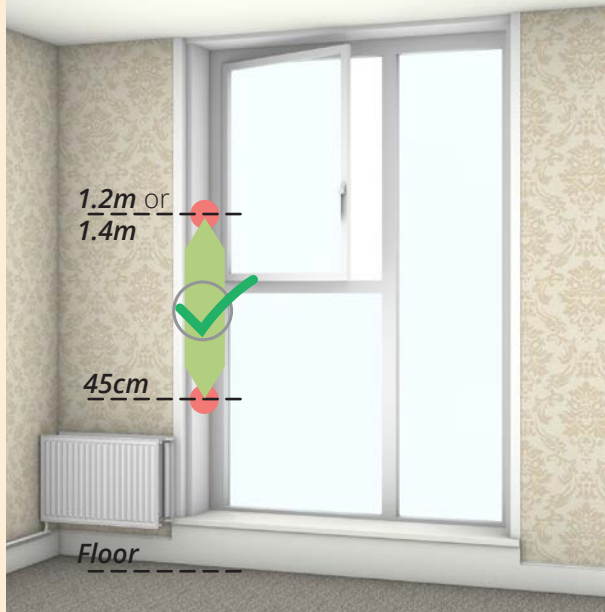

Living room:  
45cm to 1.2m  
Bedroom:  
45cm to 1.4m  
Max. depth:  
60cm  
Optional, wheelchair specific flats:  
70cm to 1m, no obstructions

*Without obstruction:* Window handle or remote opening device should be 45cm to 1.4m height



Kitchen:  
45cm to 1.4m  
Max. depth:  
60cm  
Optional, wheelchair specific flats:  
70cm to 1m, no obstructions

*With obstruction:* Window handle or remote opening device should be 45cm to 1.4m height

As the requirements for adaptable dwellings cannot be achieved at Chalcots due to the existing window layout Camden will provide alternative window control options for disabled residents and residents with limited mobility. There are several options to lower the window control and the two options shown here are illustrative examples:

### OPTION FOR ELECTRIC BUTTON:

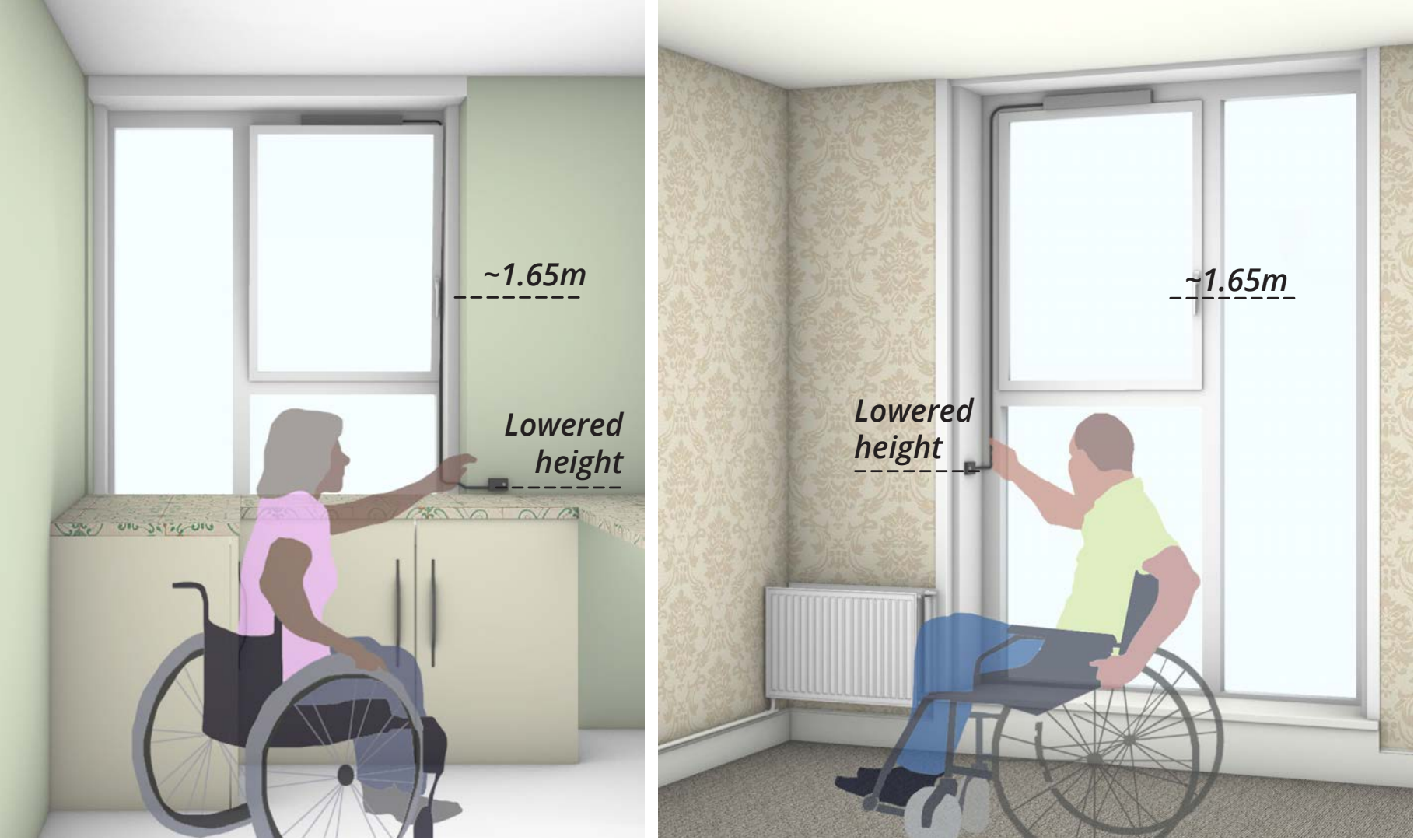

Illustrations showing possible positions for a button to operate windows.

### OPTION FOR HANDLE EXTENDER:

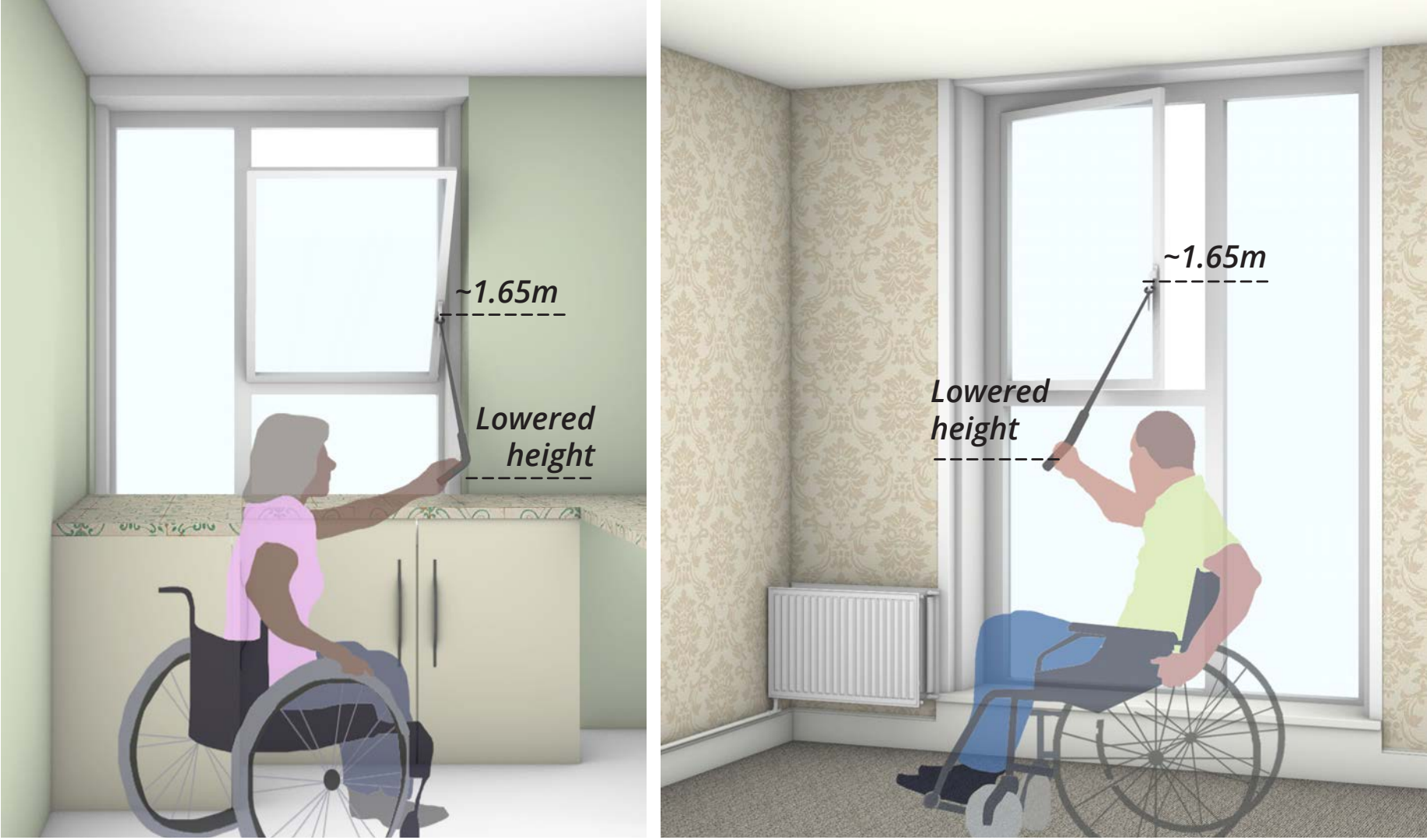

Illustrations showing a handle extender to operate windows. Handle extenders could be attached to the windows or separate devices.



## NEW WINDOWS

### VERTIGO / COVERING THE GLAZED PANELS

For residents who suffer from vertigo or prefer more privacy in their homes, a film can be applied to the new lower glass panels in the lounges and bedroom.

Examples of these vinyl films can be seen in the images to the right. The films will block views through the lower glazed panels but still let light through. The location of the film can be customised depending on requirements.

The illustration to the right shows what this might look like in a lounge. The film can also be used on bedroom windows where the window sill has been lowered.

The reason the windows have to be lowered in lounges and bedrooms is explained on Pages 20 & 21, and the decision to make the new panel glazed is explained on Page 55.



*Illustrative view of a lounge where the lower two glazed panels have been covered with frosted vinyl film. Note location of the film can be customised depending on requirements. The film may also be applied in bedrooms where the window sill has also been lowered. In the future it is easy to remove the film if a new resident would like to see through the lower part of the window.*



*Example photos of film on windows. Note a supplier has not yet been chosen so these are photos from various suppliers.*

## NEW WINDOWS

### VENTILATION & VIEWS INTO BATHROOMS

The new bathroom windows can open to 10cm and to a max of 40° which is further than the existing bathroom windows.

The 10cm setting is sufficient for normal ventilation requirements. The 40° setting will generally be used for purge venting only (see Page 14).

The glass will be frosted to block views. A high level of privacy is achieved, as demonstrated by the views from outside and inside viewpoints.

When the window is open at the full 40° setting, the internal window reveals help to block the majority of the views in.

#### ILLUSTRATIVE VIEWS, WINDOW OPEN 10CM



*Illustrative external view of bathroom window open at 10cm Tilt*



*Illustrative view from bathroom to opposite flat - 10° opening*

#### ILLUSTRATIVE WORST-CASE SCENARIO VIEWS FROM OUTSIDE INTO BATHROOM

The views below show what it would look like if you were standing outside a bathroom window. This represents the worst-case scenario as this would generally not be possible except on the ground floor. Views from other flats will be more restricted (see views from inside below). The illustrations below show the 40° setting as this would represent the worst-case in terms of privacy, but the 40° setting will generally be used for purge venting only, for example after a bath or a shower (see Page 14). For normal background ventilation the 10cm setting would be sufficient in most cases.



*Illustrative external views of a bathroom window, open at 40° Tilt setting*

#### ILLUSTRATIVE VIEW FROM INSIDE A BATHROOM TO THE OPPOSITE FLATS

The views below are taken from inside a bathroom. They illustrate what you will be able to see (or not see) of the bathrooms opposite. The area circled by a dotted red line is the area exposed in the other flat when the window is open. We have shown the 40° setting in the illustrations as this would represent the worst-case in terms of privacy but for normal background ventilation the 10cm setting would be sufficient in most cases (see Page 14).



*Illustrative view from bathroom to opposite flat*

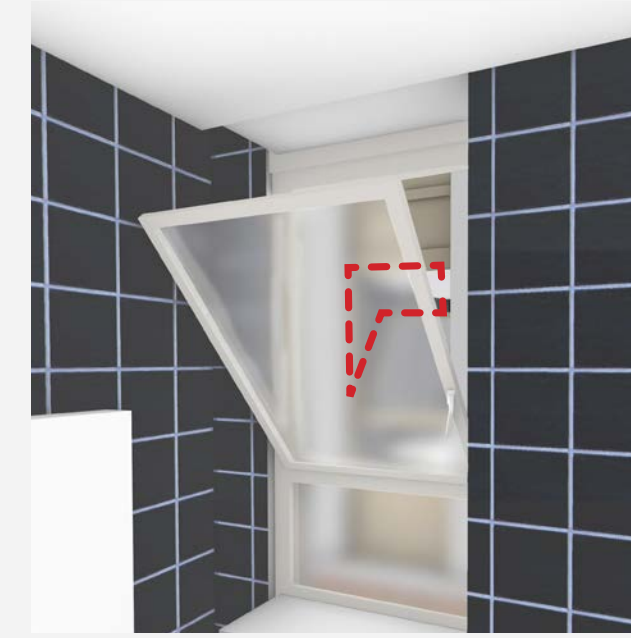

*Illustrative view from bathroom to opposite flat*

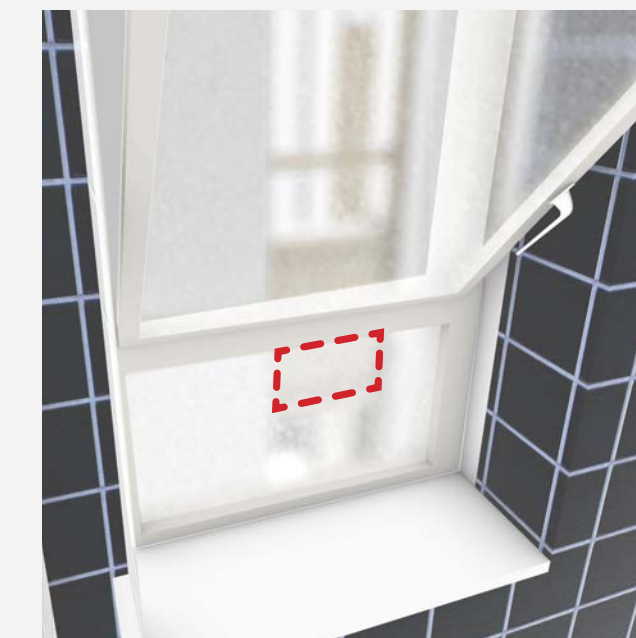

*Illustrative view from bathroom to flat opposite below*



*Illustrative view from communal space to flat opposite*

08

## CURTAINS & BLINDS

# CURTAINS & BLINDS

## BLINDS ON THE WINDOWS

This page looks at how the new window can open to allow for ventilation when the blinds are fitted onto the window panels.

Each blind can be opened and closed individually, so different levels of privacy can be obtained during the day.

The blind can remain closed when the window is open.

However, if the window is unlocked and allowed to open to 90° then light would come through the open window.

Further options for curtains are shown on the following pages.

For all opening settings, please refer to Pages 13 & 14.



**Blind** closed



**Window** closed

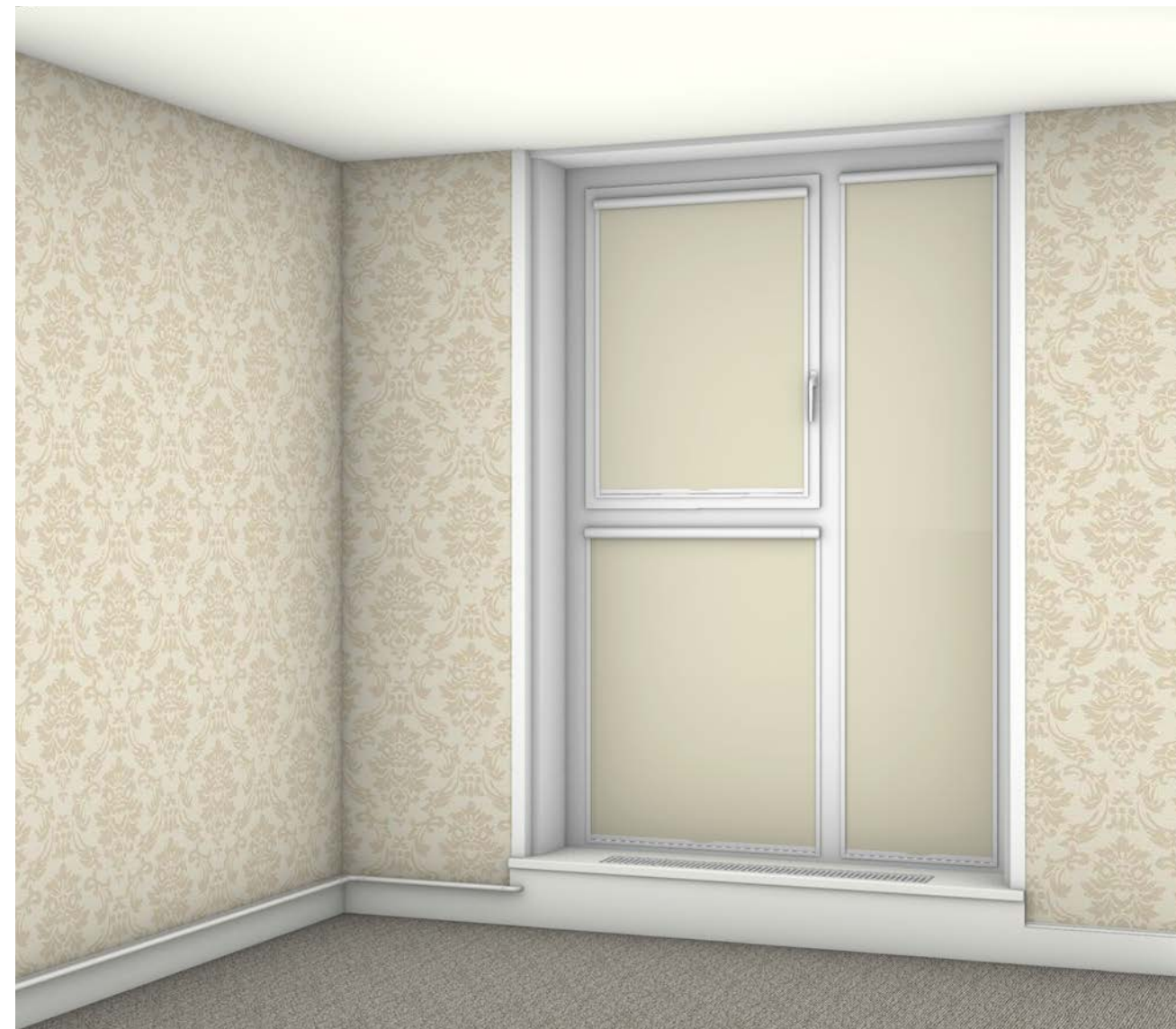

*Illustration 1: Blind closed and window closed*



**Blind** closed



**Window** open 10cm

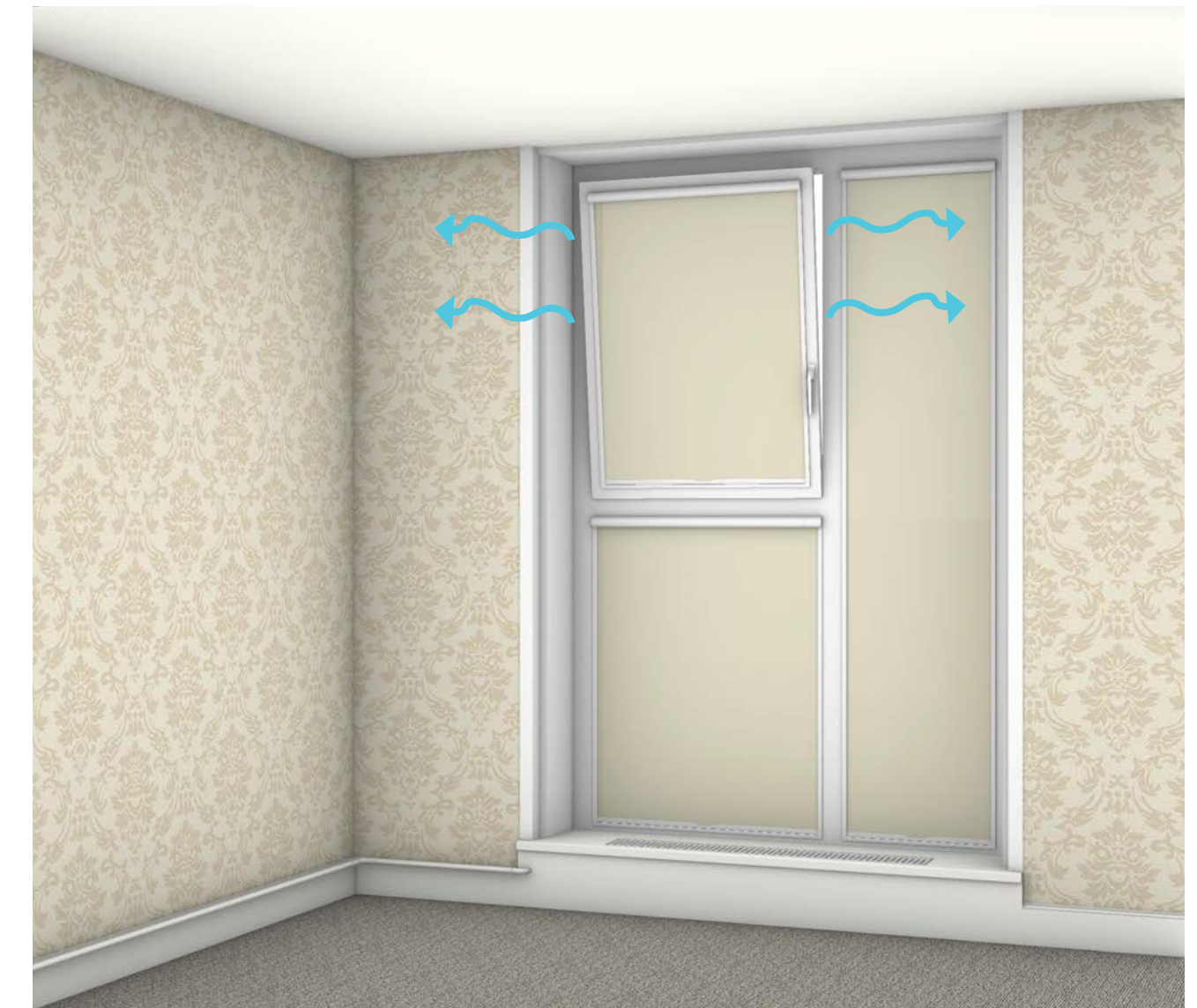

*Illustration 2: Blind closed and window open 10cm*

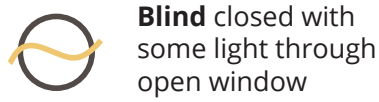

**Blind** closed with some light through open window



**Window** open 30cm

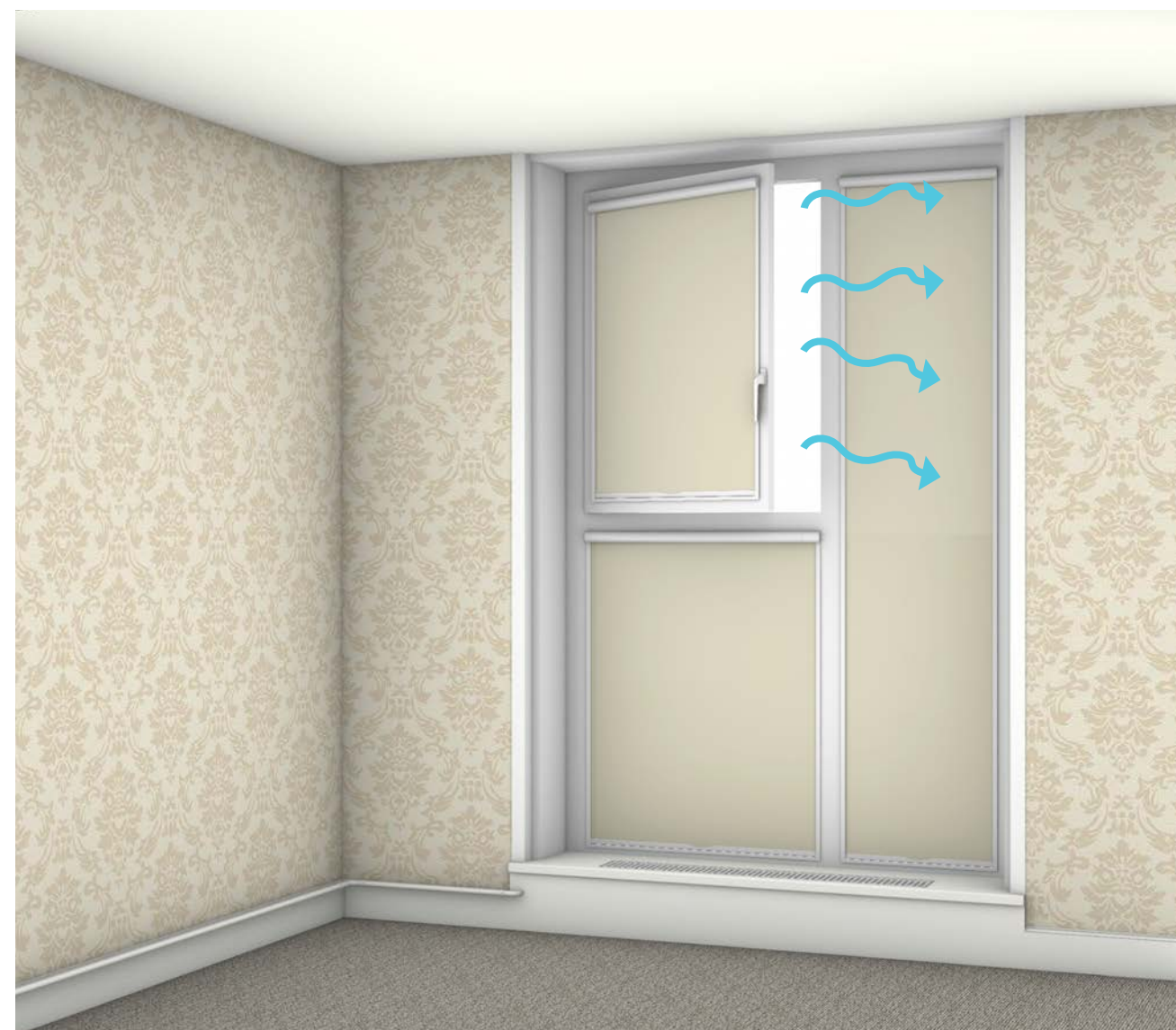

*Illustration 3: Blind closed and window open 30cm*

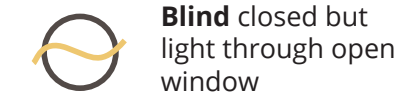

**Blind** closed but light through open window

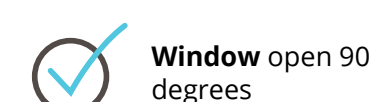

**Window** open 90 degrees

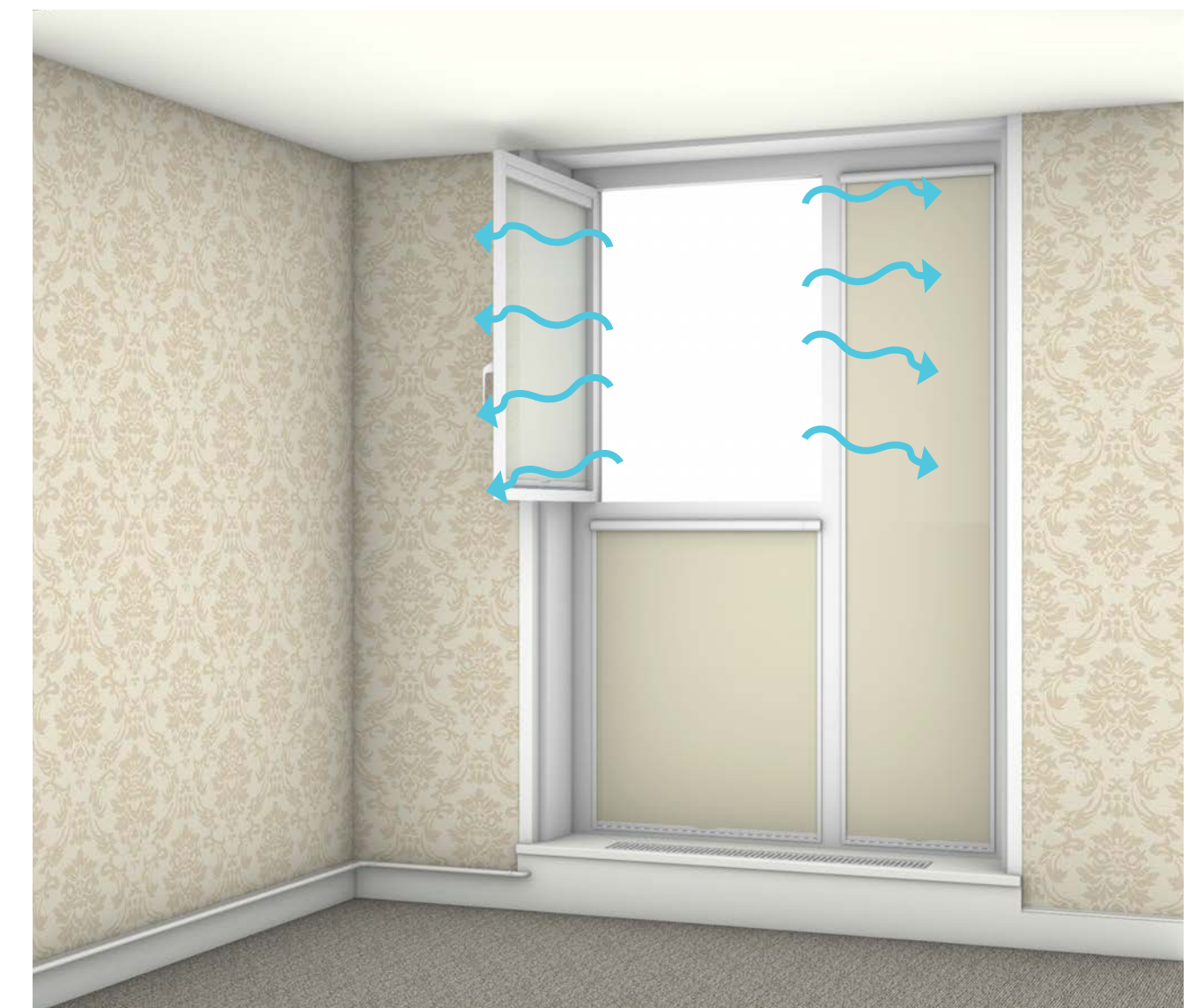

*Illustration 4: Blind closed and window open 90 degrees*

# CURTAINS & BLINDS

## CURTAIN INSIDE WINDOW REVEAL

This page looks at how the new window can open to allow for ventilation when a curtain is fitted inside the window reveal.

The window can open to 10cm or 90° and the curtain can still close around the window (provided the rail allows for the curtain to be pulled to the right of the window - as per illustration 3). Opening the window 90° is optional and the window would have to be unlocked twice. If preferred, it can be locked so it can't open 90°. For all opening settings, please refer to Pages 13 & 14.

To open the window 30cm also requires a key. The curtain could be closed partially (see illustration 4).

Further options for curtains and blinds are shown on the previous and following pages.

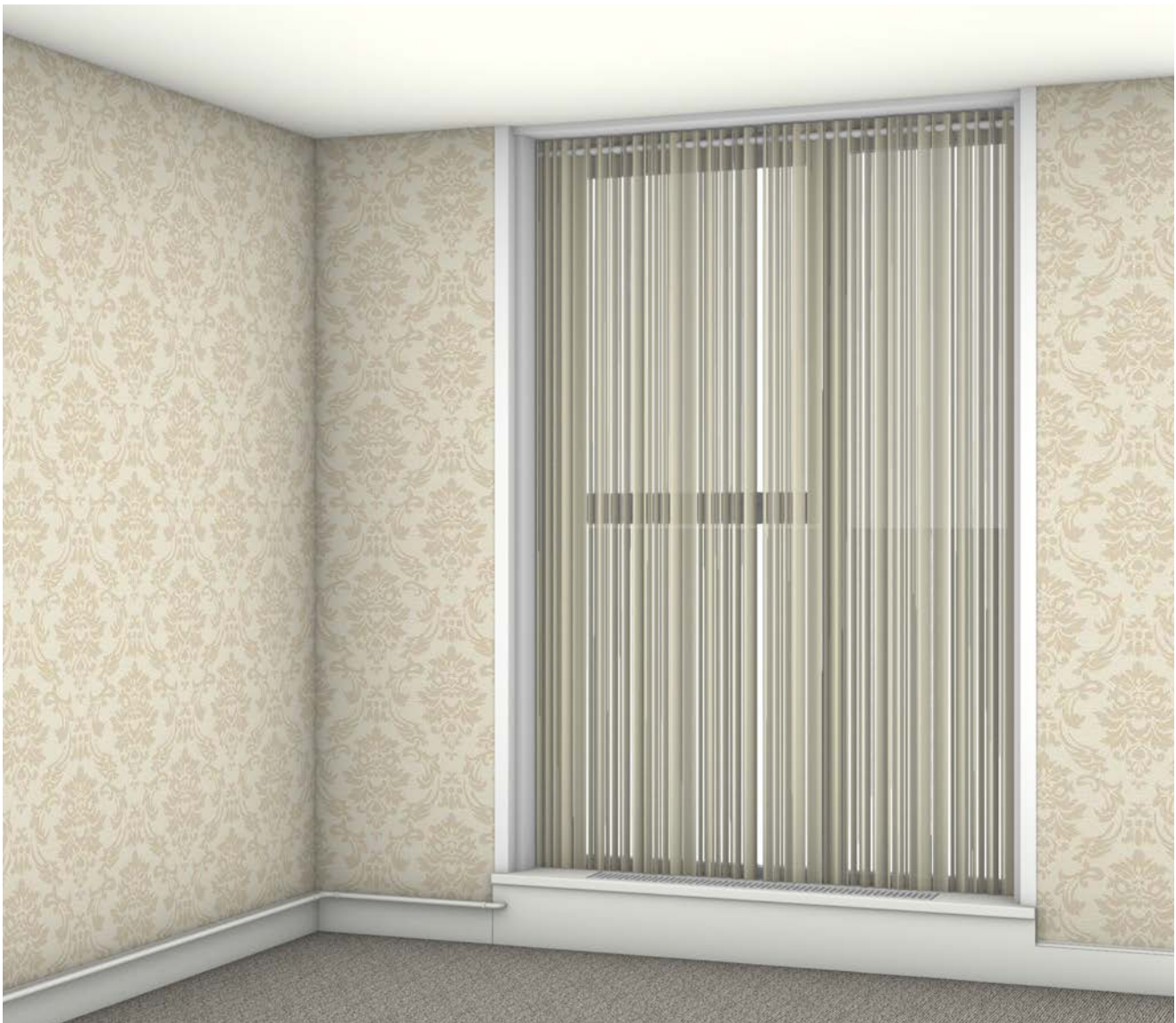

Illustration 1: Curtain closed and window closed

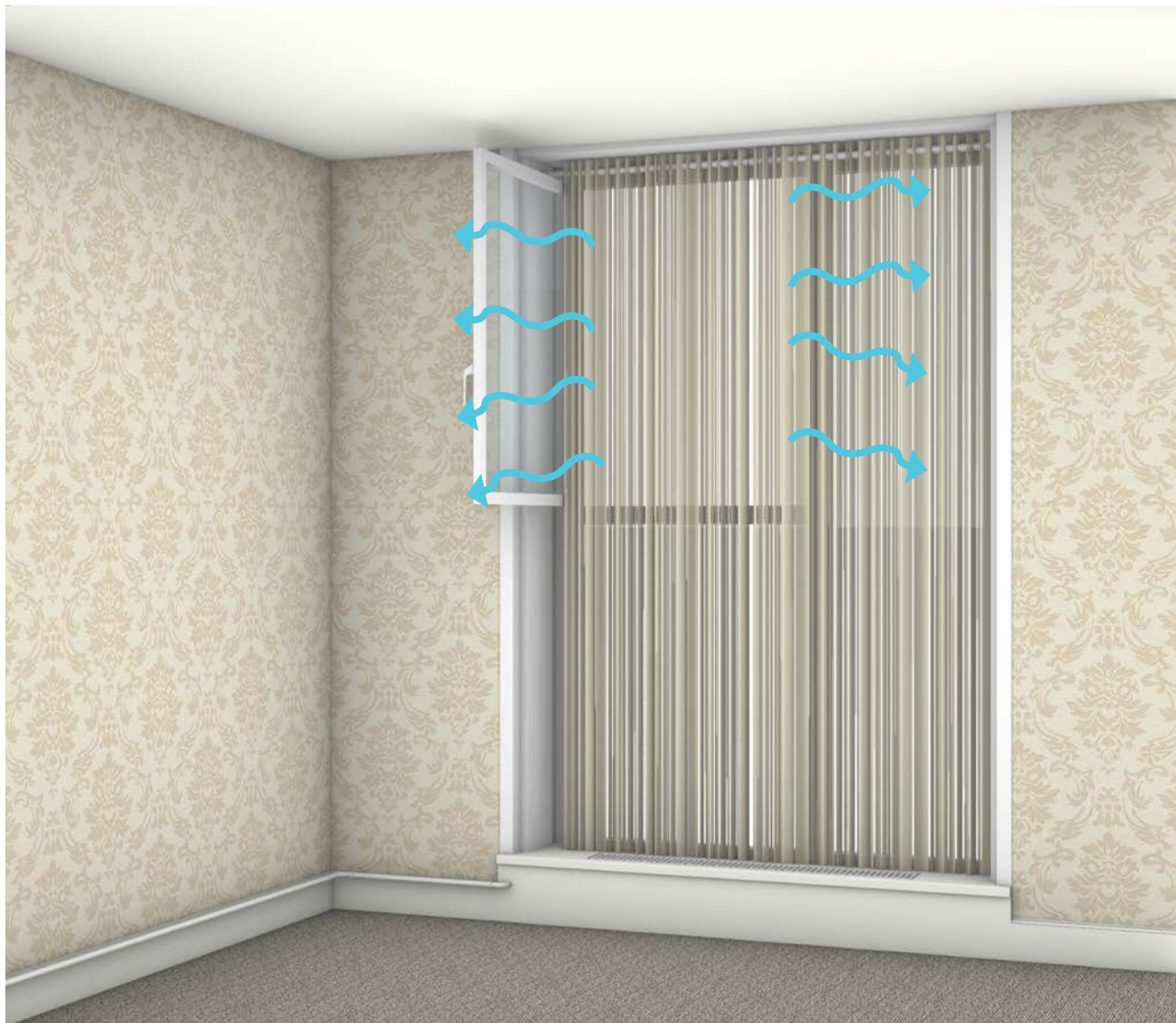
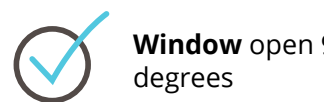

Illustration 3: Curtain closed and window open 90 degrees



Illustration 2: Curtain closed and window open 10cm

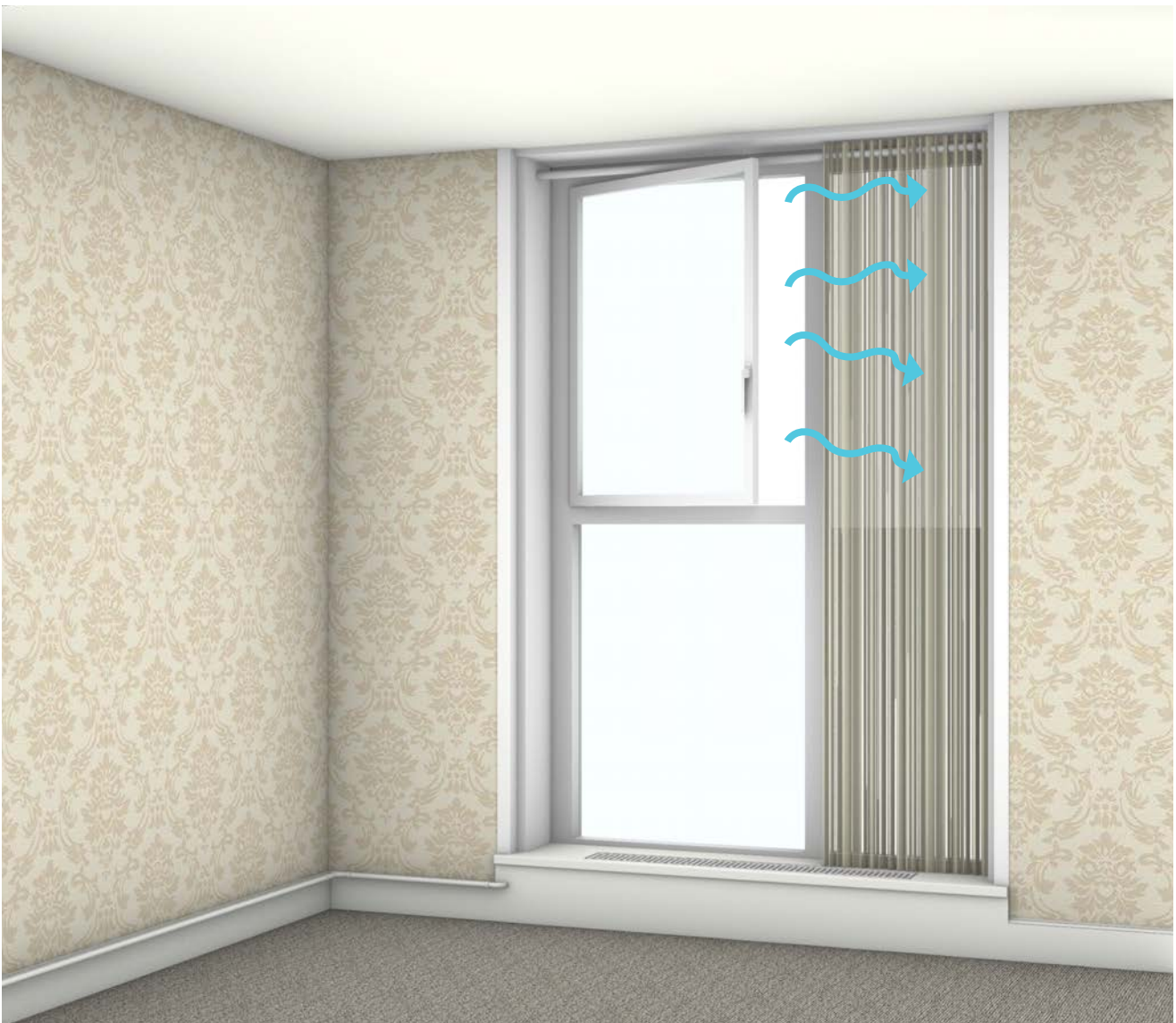
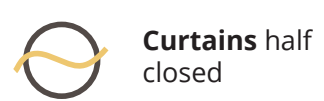

Illustration 4: Curtain half open and window open 30cm

**CURTAINS & BLINDS**  
**CURTAINS WALL-MOUNTED**

This page looks at how the new window can open to allow for ventilation when a curtain is fitted outside the window reveal, on the wall.

Here, the window could open 10cm while the curtain remains closed. The window can open 30cm if the window reveals are around 30cm, as the curtain is fitted outside the window reveal. It can open 90° if the curtain can be pulled along the rail to the right, as shown in illustration 3.

There is also an option to partially close the curtains and open the window as shown in illustration 4.

Further options for curtains and blinds are shown on the previous pages.

- 
-  Curtains closed
-  Window open 10cm



*Illustration 1: Curtain closed and window open 10cm*

- 
-  Curtains closed
-  Window open 90 degrees





*Illustration 3: Curtain closed and window open 90 degrees*

- 
-  Curtains closed
-  Window open 30cm



*Illustration 2: Curtain closed and window open 30cm*

- 
-  Curtains partially closed
-  Window open 300mm



*Illustration 4: Curtain partially closed and window open 30cm*



# HEATING

## WHAT ARE THE OPTIONS FOR THE NEW RADIATORS?

In the lounges and bedrooms, the radiators will need to be replaced (see Page 20 for why the window sill is changing).

2 options will be offered based on residents feedback. These include traditional style radiators, or trench heaters embedded in the window sill. Both systems can heat the room effectively, and both systems would work with a possible future heat pump system to reduce carbon emissions. This project does not include replacing the heating system, but the new radiators would be compatible with other heating systems such as heat pumps.

In the original tender only traditional style radiators were proposed but as residents were concerned about the space requirements for these radiators, two radiator options are now offered 1) the traditional radiator and 2) the trench heater, which takes up no additional space in the room.'

The exact model and appearance of radiators will be confirmed once the contractor is appointed. Trench heaters are most often controlled by wall mounted thermostats such as the example below. The thermostat would be fitted on the wall on either side of the window.



Example control for a trench heater

### OPTION 1: RADIATOR



Illustrative example: lounge with new radiator

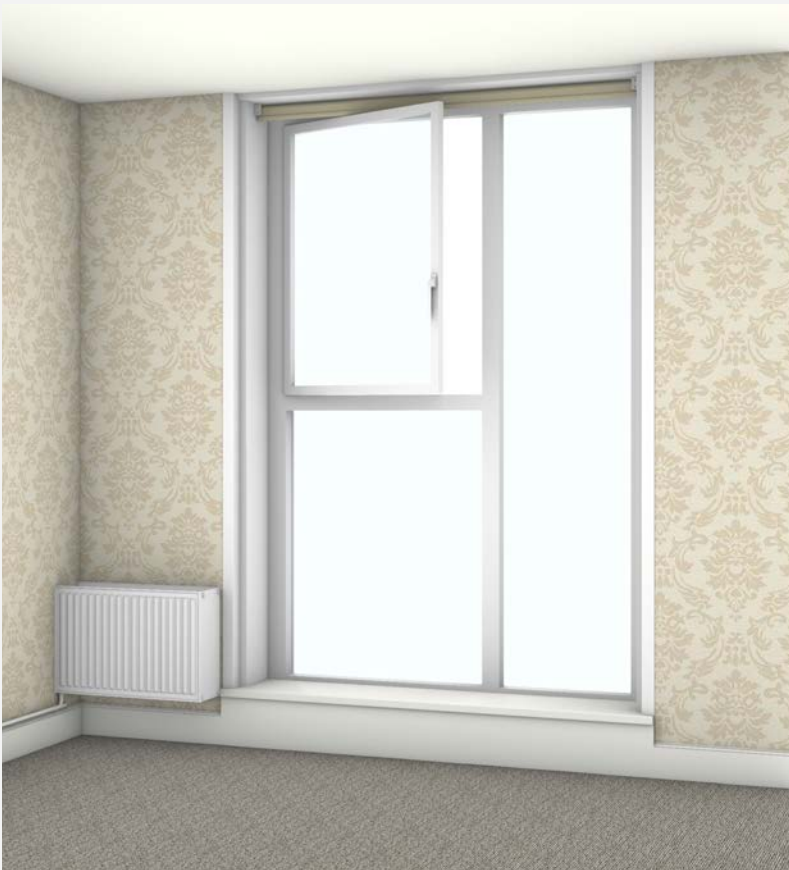

Illustrative example: bedroom with new radiator

### OPTION 2: TRENCH HEATER



Illustrative example: lounge with trench heater



Illustrative example: bedroom with trench heater

**EXAMPLE PRODUCT:**

**Trench heater model:**  
Kampmann Katherm QK 190

**Output at 40% fan speed:**  
Bedrooms (1m): 559W  
Living rooms (1.2m): 864W



## CAN I HAVE THE TRENCH HEATER ON AT NIGHT WHEN THE CURTAINS ARE CLOSED?

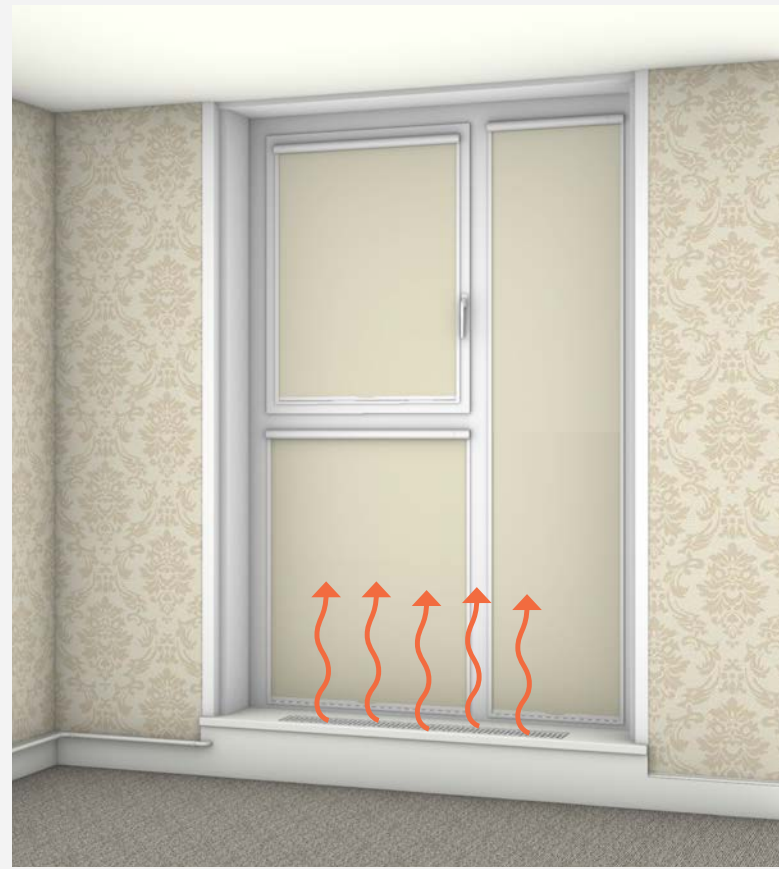

Illustrative example: bedroom

Scenario 1:

### ROLLER-BLIND INSIDE THE CURTAIN REVEAL

The roller blind can be installed behind the trench heater. The trench heater can be turned on when the blind is shut and will effectively heat the room.



Illustrative example: bedroom

Scenario 2:

### CURTAIN INSIDE THE CURTAIN REVEAL

The curtain can be installed behind the trench heater. The trench heater can be turned on when the curtain is closed and will effectively heat the room.

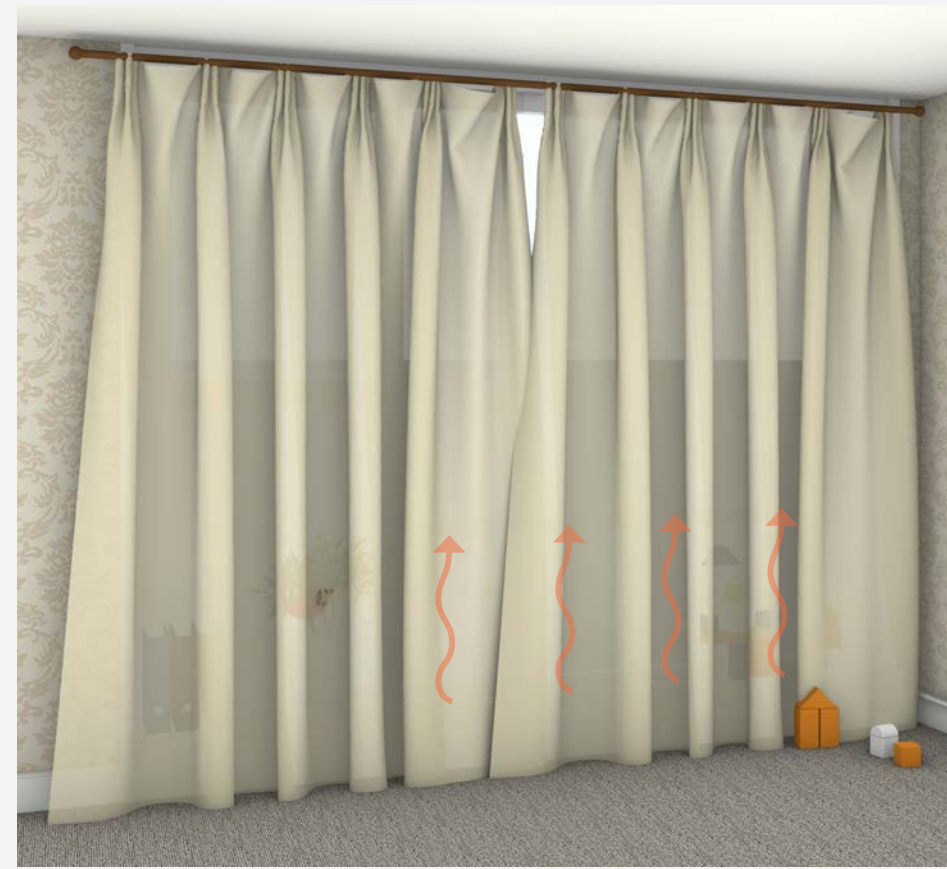

Illustrative example: lounge

Scenario 3:

### WALL-MOUNTED CURTAIN IN FRONT OF THE WINDOW SILL

The trench heater can be turned on when the curtain is closed, however it will be less effective as the hot air won't be able to circulate around the room as easily.

## ARE THE TRENCH HEATERS NOISY?



The trench heaters use a fan to help circulate the warm air around the room.

The trench heater will make a noise of approximately 20dB or less. 20dB is roughly equivalent to rustling leaves or whispers. A show flat will be fitted out by the contractor where radiators and trench heaters will be available for viewing.

**IS IT EASY TO MAINTAIN THE TRENCH HEATER?**



The fan in the trench heater will be maintained by Camden with an annual service.

There is also a safety cut out function for the fan to shut off under faulty conditions. The trench heater will comply with the relevant fire safety standards.

&

**WHAT IF I DROP SOMETHING IN THE TRENCH HEATER?**

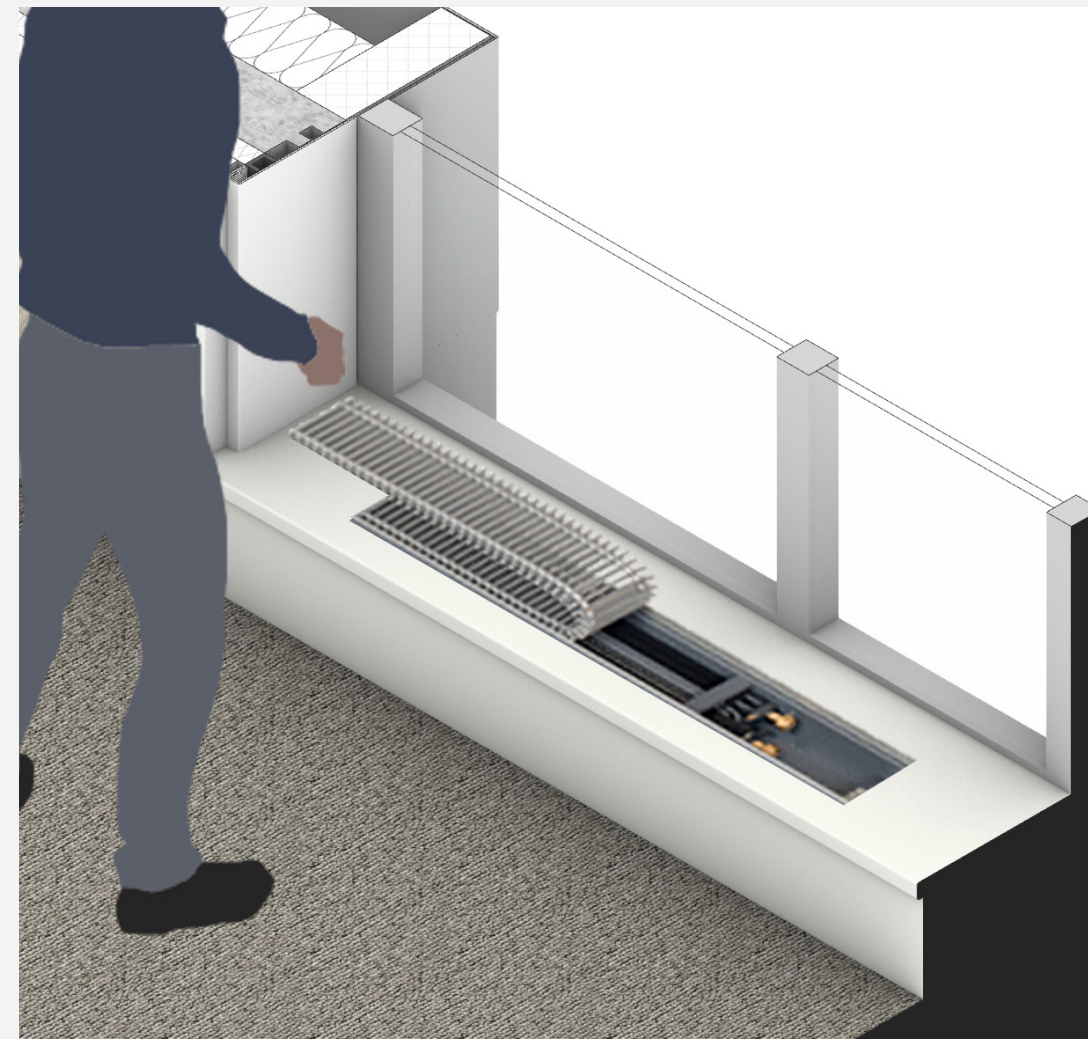

If an item falls through the grille it can be retrieved by rolling the grille back. It is relatively easy to roll back the grille and the surface temperature of the radiator unit is no higher than a conventional radiator.

**WHAT IF SOMEONE LEAVES PAPER ON THE TRENCH HEATER?**



The fan in the trench heater is a low fire risk, and is comparable to other electronic devices failing in your home.

If objects such as paper or books are left on the trench heater, they will limit the effectiveness of the trench heater to heat the room. However, they would not be a fire risk. Paper ignites at 200°C, and the heat source in the trench heater will only reach a maximum of 75°C.

**CAN THE HEATER BE TURNED TO FACE INWARDS?**

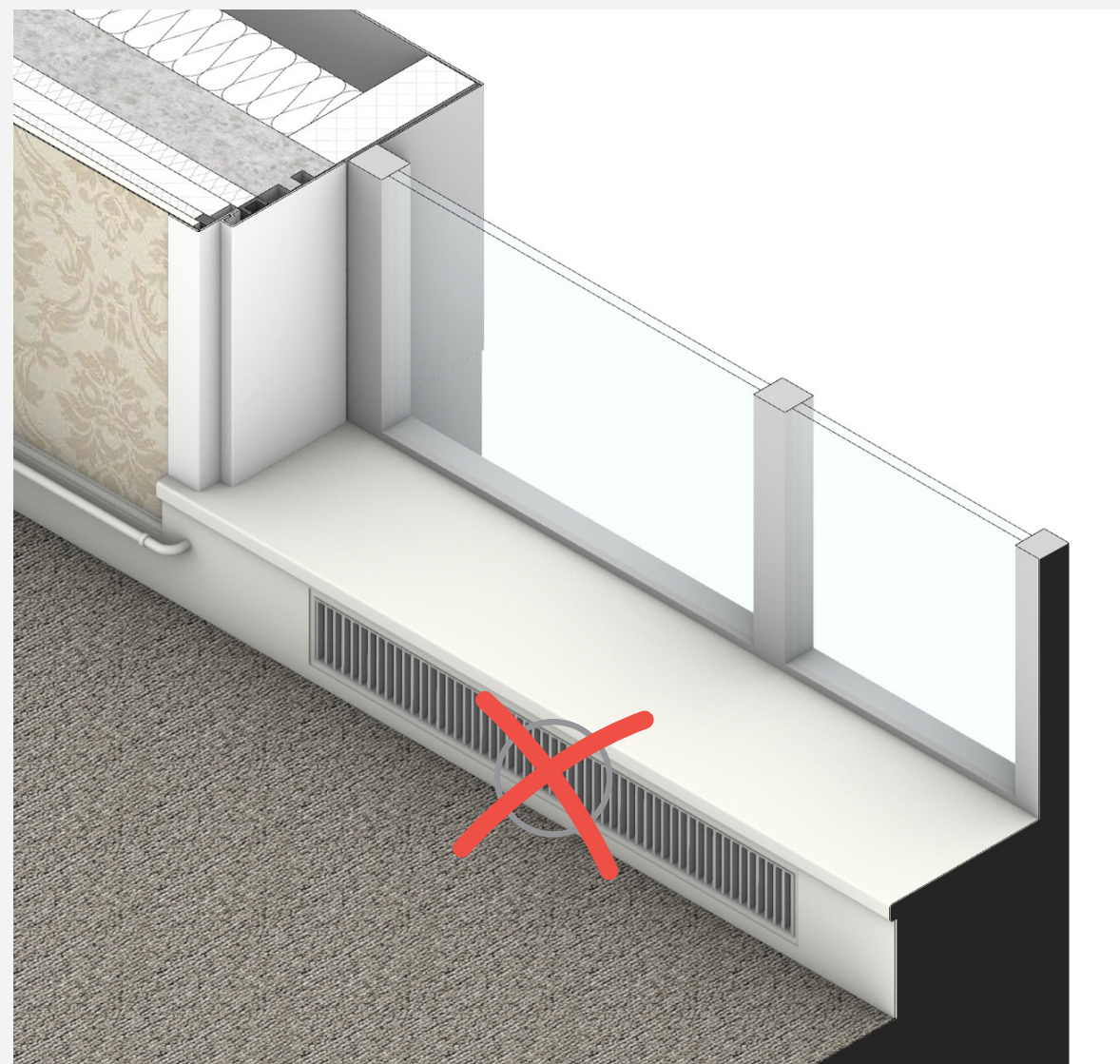

Turning the heater to face the room would not create adequate heating for the room as the heat would not circulate effectively. A larger heater would be required which would be difficult to fit in the window sill.

**WILL THERE BE SPACE FOR PLANTS OR STORAGE ON MY WINDOW SILL?**



In living rooms, there will be approximately 60cm of sill space available on each side of the trench heater. This could be used for plants or other items.

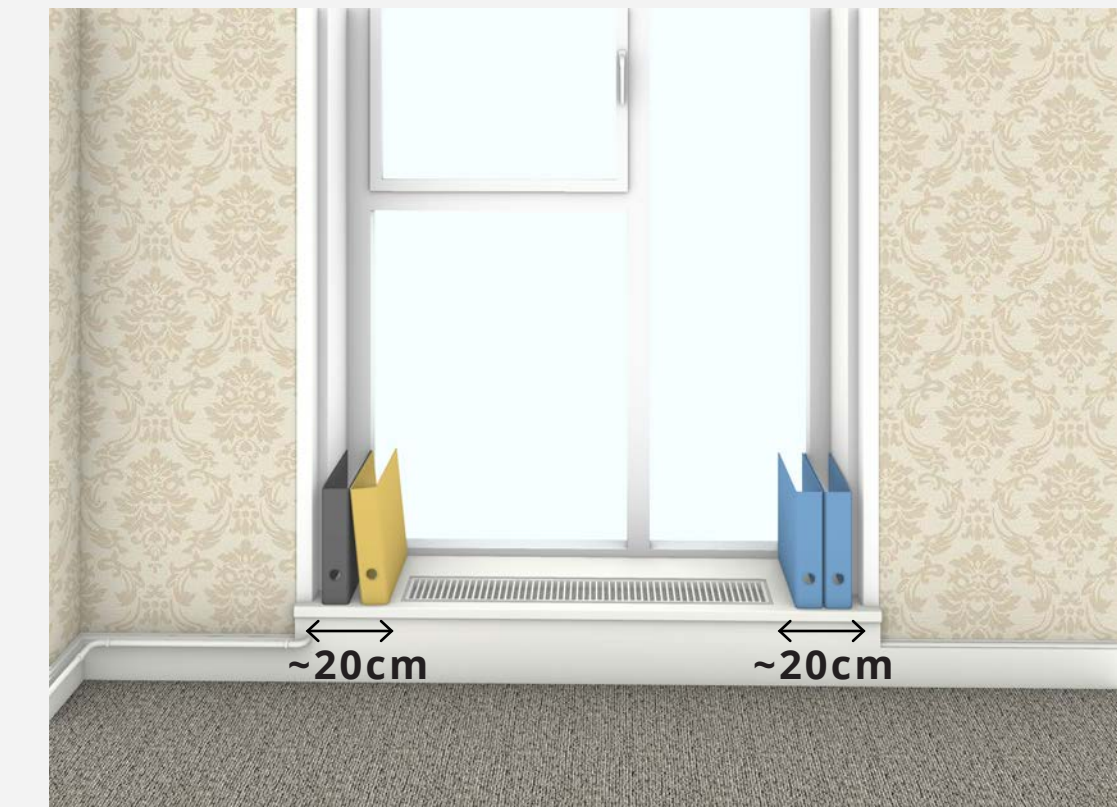

In bedrooms, there will be approximately 22cm of sill space available on each side, leaving room for fewer items such as a couple of books.

**IS THERE A RISK OF A CHILD BURNING THEIR FEET BY STANDING ON THE GRILLE?**



The surface temperature of a traditional radiator is 70 - 75°C. These temperatures do not pose a risk of burning without prolonged contact.

This is the same temperature that the trench heaters will run at but the surface of the heating element will be protected by the grille. Manufactures advise that the air temperature at the grille is around 20°C lower than the inlet water temperature and therefore the grille will not exceed around 45°C.

This is **a significantly lower temperature than the existing radiators surface temperature** and so burns are not an increased risk over the existing condition. Please note 43°C is considered the temperature that is suitable for hospitals and high risk environments.

**ARE TRENCH HEATERS EXPENSIVE TO RUN?**



The electricity consumption to operate the fan for the radiator inside the window sill can be compared to the electricity consumption of an LED lightbulb.

A normal LED lightbulb is between 8-10 W, so the fans are using **half as much power as a lightbulb**.

Assuming residents have the fan on for around 8 hours a day in the heating season this would cost approximately **50p per year per trench heater**.

In a worst case scenario where the fan was turned up to maximum capacity and left on 24hrs a day in the heating season this could rise to around £2 per year per trench heater.

**WILL THE TRENCH HEATERS WORK WITH THE EXISTING RADIATORS?**

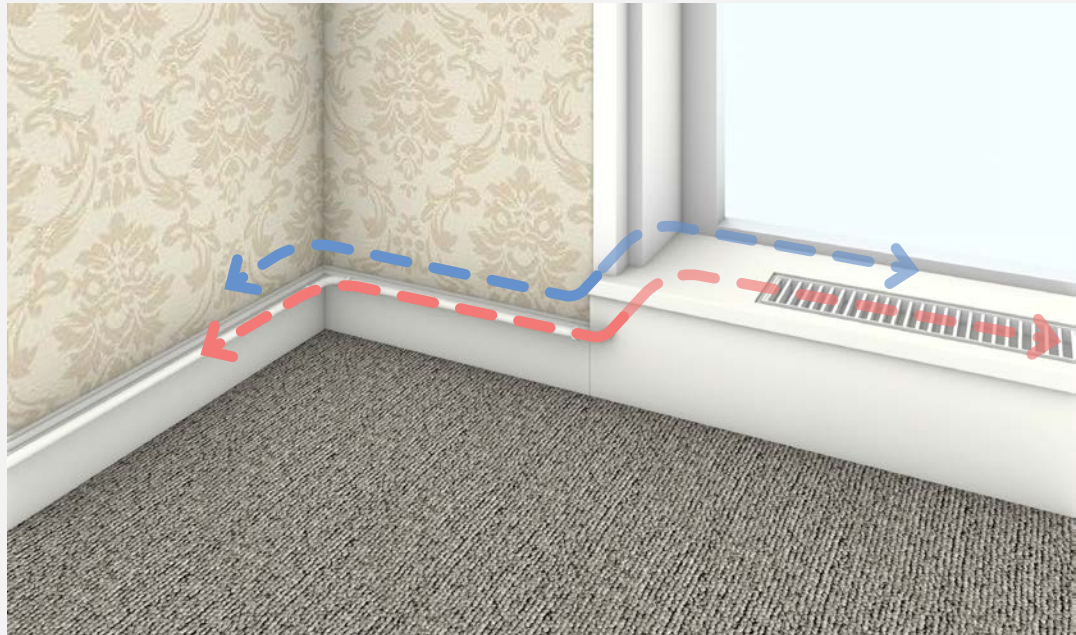

← - - - Connection to power circuit  
← - - - Connection to pipework

Yes, the new trench heaters and/or wall mounted radiators will work with the existing radiators. The fan required for the trench heaters will be hard wired into the in-home power circuit. The radiators will all be flushed through and tested after installation and before handover.

Only radiators in the lounge and bedrooms are to be replaced. Replacing other radiators is not part of the major works but Camden are discussing the potential to replace older radiators that are not part of the major works project.

## ARE THERE EXAMPLES OF TRENCH HEATERS USED IN RESIDENTIAL SETTINGS?

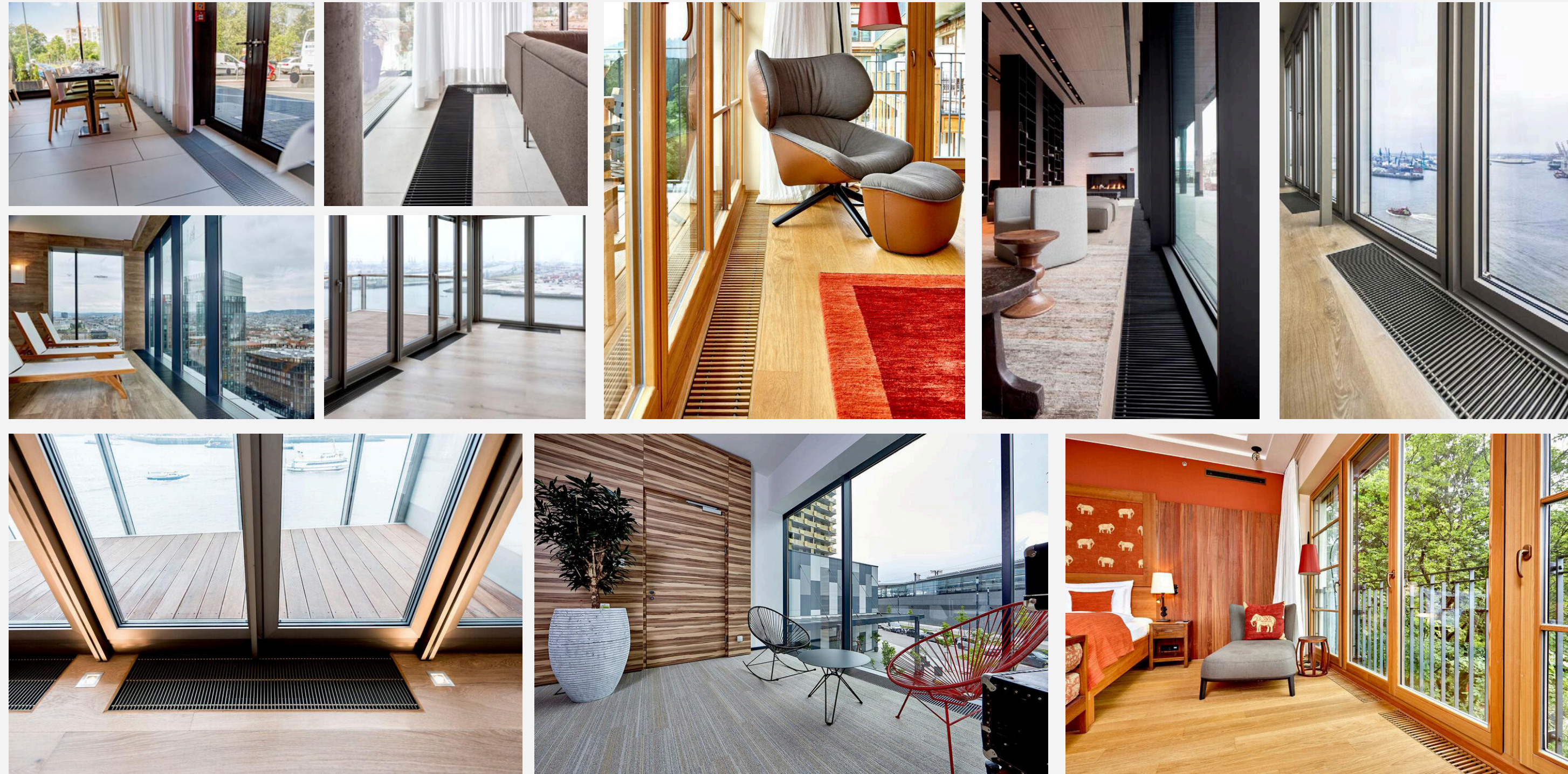

Photos courtesy of Kampmann UK Ltd

Yes. Trench heaters are used in residential settings, such as the high-end new flats at One Hyde Park. The Kampmann trench heaters comply with the British Standard BS EN 16430 which ensure that units are a safe and tested heating option.

The images above show examples of Kampmann Katherm HK trench heaters used in residential and hotel settings.

## CAN THE WINDOW SILL SLOPE DOWNWARDS INTO THE ROOM TO PREVENT DAMAGE FROM STANDING ON THE SILL?



The sill would have to be substantially sloped in order to prevent someone from standing on it and, as result, would also result in the loss of storage space. Sills will be designed to not get damaged through normal use.

As the window sill is an important storage space for many residents, the option to slope the window sill is currently not considered a viable option.



# A CLOSER LOOK AT: HOW DID WE DECIDE TO MAKE THE NEW PANEL GLAZED?

## SILL DROPPED TO INCREASE SAFETY

The lowered window sill in bedrooms and lounges means that even if someone stands on the window sill, there is a safe guarding height to prevent falling.

See Pages 20-21 for further information about why the sill was lowered.



## THE NEW PANEL COULD BE GLAZED OR OPAQUE

**New windows with an opaque panel option or a glazed panel option both provide significant improvements** in terms of overheating compared to the existing windows due to the improved G-Value of the glass, as shown by the graph below.

The glazed panel option reduces heat gains by around 43% compared to 61% for the opaque panel option on the average hottest day in the worst case scenario: a South-West facing room.

An Integrated Environment Solutions calculation model was used for the analysis. Results are shown below:

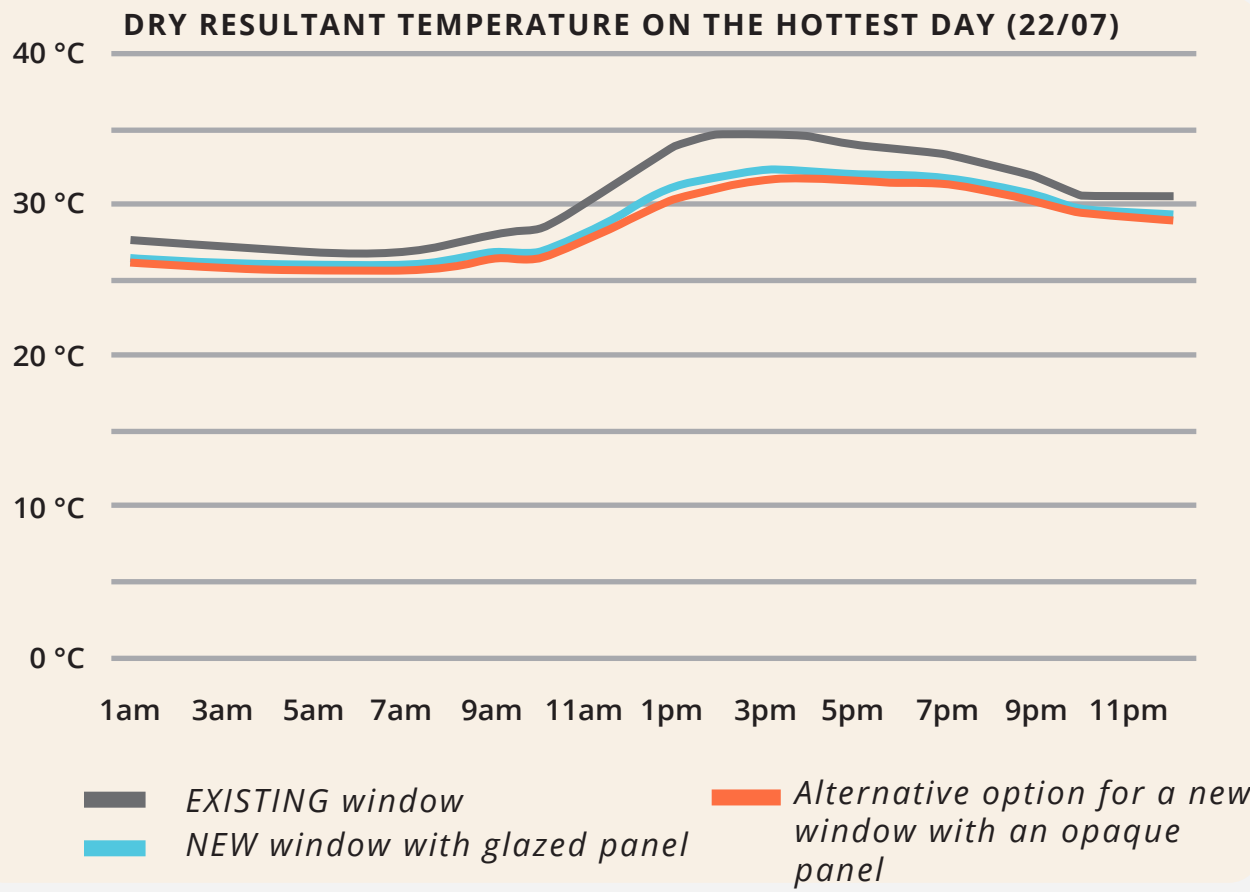

2020 Window System Options report, Appendix A / Heat Gains

## BOTH OPTIONS PROVIDE BENEFITS, SO THE CHOICE WAS GIVEN TO RESIDENTS

The outcome of the June 2019 resident engagement led by Camden showed that glazing was the most popular option and therefore the decision was made to include a glazed panel in the new window design.

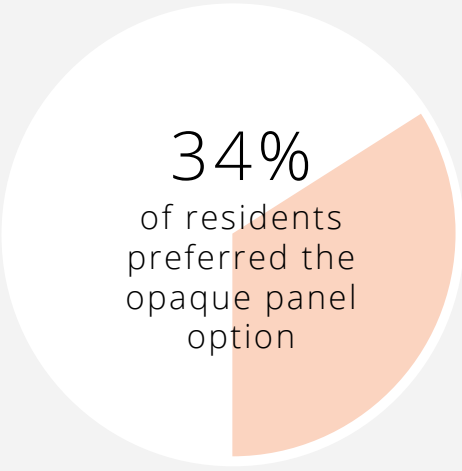

## NEW GLAZED PANEL

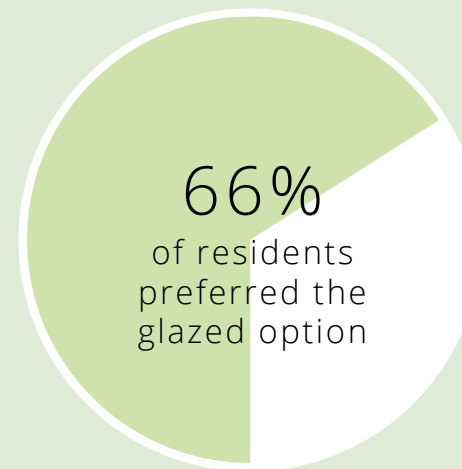

For those who preferred opaque panels, a film can be applied to the glazed panels if the resident chooses to, for example if they have vertigo. See Page 41 for more information.

ANALYSING THE OPAQUE VS. GLAZED LOWER PANEL

**OPAQUE VS GLAZED PANEL OVERHEATING RESULTS: CRITERION A 2011 - 2040**

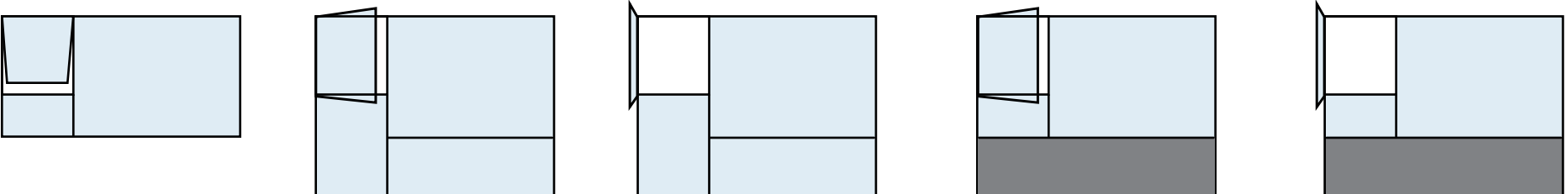

**DO THE NEW WINDOWS MEET BUILDING REGULATIONS?**

Yes, both the glazed and spandrel panel windows meet regulations. The testing has been carried out to ensure the new windows perform better than the existing windows. The windows do not need to pass the CIBSE TM59 test as this is not a requirement under the Building Regulations.

**Both the new windows and the previous alternative with a spandrel panel perform better than the existing windows.**

**WILL THIS SCENARIO DEFINITELY HAPPEN?**

This analysis is based on predicted temperatures that may or may not occur. There is approximately a 1-in-7 chance of future summers being equal or hotter than the baseline summer temperatures used (the DSY1 file). A 'high emissions' scenario is used to predict climate change. See Page 30.

**HOW MUCH DIFFERENCE DOES THE SPANDREL MAKE?**

If this scenario occurs, both window types provide improvements for all rooms within the existing towers and greatly reduce the likelihood of overheating.

The spandrel panel performs slightly better than the glazed panel in the CIBSE TM59 test but the difference is not significant so residents were given a choice.

For more information refer to Page 30 and Page 55.

		Existing 30cm Tilt Out	New: GLAZED PANEL		Alternative: SPANDREL PANEL	
			30cm Turn In	90° Turn In	30cm Turn In	90° Turn In
Flat A	Bedroom	4.0%	1.5%	1.5%	0.8%	0.8%
	Bedroom	5.2%	1.9%	1.9%	0.8%	0.8%
	Bedroom	5.7%	2.3%	2.2%	0.9%	0.9%
	Kitchen	4.7%	n/a	n/a	n/a	n/a
	Living Room	9.5%	5.8%	4.2%	4.7%	3.1%
Flat B	Bedroom	1.2%	0.8%	0.8%	0.7%	0.7%
	Bedroom	1.6%	0.9%	0.9%	0.7%	0.7%
	Bedroom	1.9%	0.9%	0.9%	0.8%	0.8%
	Kitchen	4.2%	n/a	n/a	n/a	n/a
	Living Room	4.1%	2.7%	2.4%	2.5%	2.1%
Flat C	Bedroom	1.7%	0.9%	0.9%	0.7%	0.7%
	Bedroom	1.8%	0.9%	0.9%	0.7%	0.7%
	Kitchen	1.5%	n/a	n/a	n/a	n/a
	Living Room	3.5%	2.7%	2.2%	2.1%	2.0%
Flat D	Bedroom	4.2%	1.1%	1.1%	0.8%	0.8%
	Bedroom	4.0%	1.2%	1.2%	0.8%	0.8%
	Kitchen	10.5%	n/a	n/a	n/a	n/a
	Living Room	6.5%	3.0%	2.5%	2.5%	2.1%
Flat E	Studio	11.3%	3.6%	3.5%	2.4%	2.3%
	Kitchen	7.6%	n/a	n/a	n/a	n/a
Flat F	Bedroom	4.9%	1.4%	1.4%	0.9%	0.9%
	Bedroom	4.9%	1.2%	1.2%	0.8%	0.8%
	Kitchen	10.2%	n/a	n/a	n/a	n/a
	Living Room	9.1%	3.8%	2.7%	2.7%	2.3%
Flat G	Bedroom	5.0%	1.7%	1.6%	0.8%	0.8%
	Kitchen	2.7%	n/a	n/a	n/a	n/a
	Living Room	7.6%	4.7%	3.2%	2.9%	2.3%

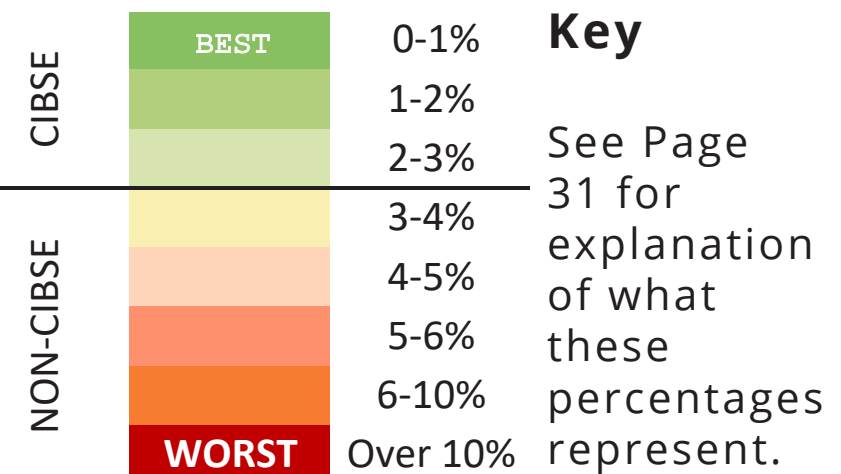
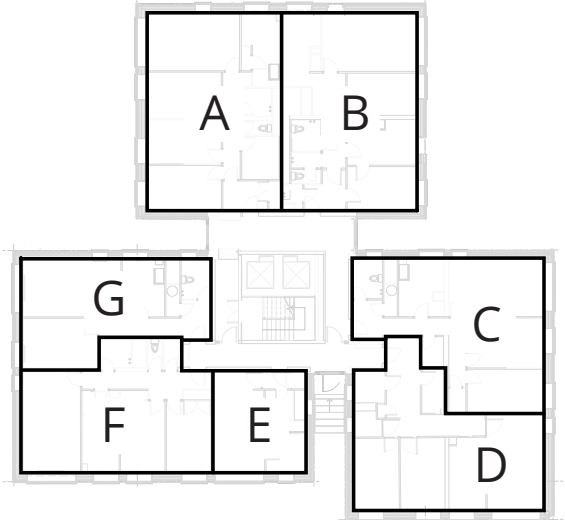



ANALYSING THE OPAQUE VS. GLAZED LOWER PANEL

OPAQUE VS GLAZED PANEL OVERHEATING RESULTS: CRITERION A 2041 - 2070

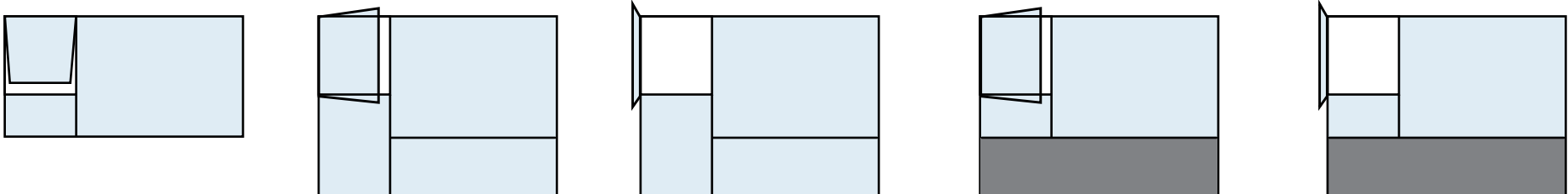

DO THE NEW WINDOWS MEET BUILDING REGULATIONS?

Yes, both the glazed and spandrel panel windows meet regulations. The testing has been carried out to ensure the new windows perform better than the existing windows. The windows do not need to pass the CIBSE TM59 test as this is not a requirement under the Building Regulations.

Both the new windows and the previous alternative with a spandrel panel perform better than the existing windows.

WILL THIS SCENARIO DEFINITELY HAPPEN?

These results predict how the windows perform during summer weather in 2041-2070, based on predicted future weather in which there has been high carbon emissions and a greater chance of extreme weather.

HOW MUCH DIFFERENCE DOES THE SPANDREL MAKE?

If this scenario occurs, both window types provide improvements for all rooms within the existing towers and greatly reduce the likelihood of overheating.

The spandrel panel performs slightly better than the glazed panel in the CIBSE TM59 test but the difference is not significant so residents were given a choice.

For more information refer to Page 30 and Page 55.

		Existing 30cm Tilt Out	New: GLAZED PANEL		Alternative: SPANDREL PANEL	
			30cm Turn In	90° Turn In	30cm Turn In	90° Turn In
Flat A	Bedroom	6.4%	3.0%	3.0%	1.6%	1.6%
	Bedroom	7.3%	3.6%	3.6%	1.8%	1.8%
	Bedroom	7.7%	3.7%	3.6%	1.9%	1.9%
	Kitchen	8.2%	n/a	n/a	n/a	n/a
	Living Room	14.0%	9.2%	7.2%	7.6%	6.3%
Flat B	Bedroom	2.4%	1.4%	1.4%	1.2%	1.2%
	Bedroom	3.2%	1.8%	1.8%	1.3%	1.3%
	Bedroom	4.2%	2.0%	1.9%	1.4%	1.4%
	Kitchen	7.8%	n/a	n/a	n/a	n/a
	Living Room	8.6%	5.6%	4.7%	4.7%	4.2%
Flat C	Bedroom	3.1%	1.8%	1.7%	1.3%	1.3%
	Bedroom	3.8%	1.8%	1.7%	1.3%	1.3%
	Kitchen	3.3%	n/a	n/a	n/a	n/a
	Living Room	7.0%	5.0%	4.4%	4.0%	3.8%
Flat D	Bedroom	7.0%	2.4%	2.4%	1.4%	1.4%
	Bedroom	6.5%	2.4%	2.4%	1.4%	1.4%
	Kitchen	15.7%	n/a	n/a	n/a	n/a
	Living Room	11.9%	6.0%	5.2%	5.2%	4.3%
Flat E	Studio	12.7%	6.1%	6.0%	4.4%	4.4%
	Kitchen	12.4%	n/a	n/a	n/a	n/a
Flat F	Bedroom	7.6%	2.7%	2.7%	1.5%	1.5%
	Bedroom	7.7%	2.7%	2.7%	1.5%	1.5%
	Kitchen	14.5%	n/a	n/a	n/a	3.0%
	Living Room	13.1%	7.8%	5.8%	6.1%	5.1%
Flat G	Bedroom	7.1%	3.3%	3.3%	1.7%	1.7%
	Kitchen	4.5%	n/a	n/a	n/a	n/a
	Living Room	11.5%	7.7%	6.4%	6.2%	5.3%

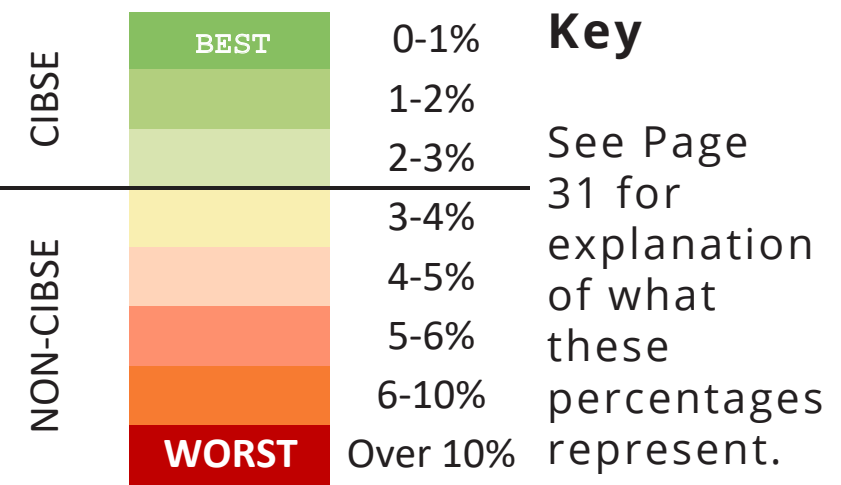
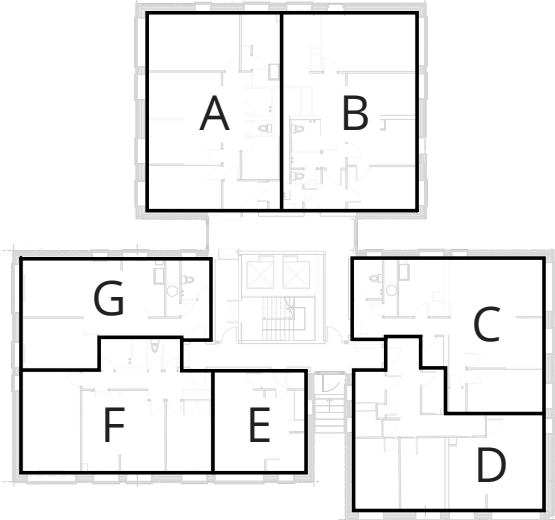

ANALYSING THE OPAQUE VS. GLAZED LOWER PANEL

**OPAQUE VS GLAZED PANEL OVERHEATING RESULTS: CRITERION B 2011 - 2040**

**DO THE NEW WINDOWS MEET BUILDING REGULATIONS?**

Yes, both the glazed and spandrel panel windows meet regulations. The testing has been carried out to ensure the new windows perform better than the existing windows. The windows do not need to pass the CIBSE TM59 test as this is not a requirement under the Building Regulations.

**Both the new windows and the previous alternative with a spandrel panel perform better than the existing windows.**

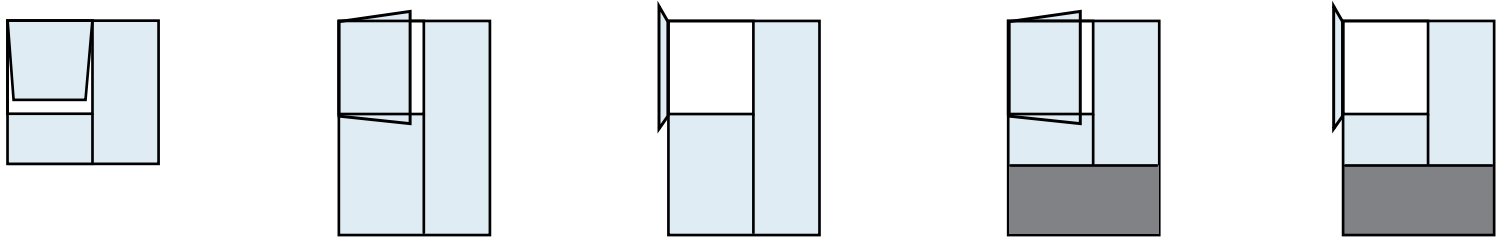

**WILL THIS SCENARIO DEFINITELY HAPPEN?**

This analysis is based on predicted temperatures that may or may not occur. There is approximately a 1-in-7 chance of future summers being equal or hotter than the baseline summer temperatures used (the DSY1 file). A 'high emissions' scenario is used to predict climate change. See Page 30.

**HOW MUCH DIFFERENCE DOES THE SPANDREL MAKE?**

If this scenario occurs, both types provide improvements for all rooms within the existing towers and greatly reduce the likelihood of overheating.

The spandrel panel performs slightly better than the glazed panel in the CIBSE TM59 test but the difference is not significant so residents were given a choice.

*For more information refer to Page 30 and Page 55.*

		Existing 30cm Tilt Out	New: GLAZED PANEL		Alternative: SPANDREL PANEL	
			30cm Turn In	90° Turn In	30cm Turn In	90° Turn In
Flat A	Bedroom	61	28	28	15	15
	Bedroom	61	28	28	15	15
	Bedroom	66	29	29	17	17
Flat B	Bedroom	45	22	22	14	14
	Bedroom	48	23	23	14	14
	Bedroom	55	27	26	17	17
Flat C	Bedroom	55	27	25	17	17
	Bedroom	53	24	24	14	14
Flat D	Bedroom	62	24	24	15	15
	Bedroom	61	26	26	17	17
Flat E	Studio	106	41	40	37	36
Flat F	Bedroom	63	25	25	16	16
	Bedroom	62	23	23	14	14
Flat G	Bedroom	62	29	28	17	17

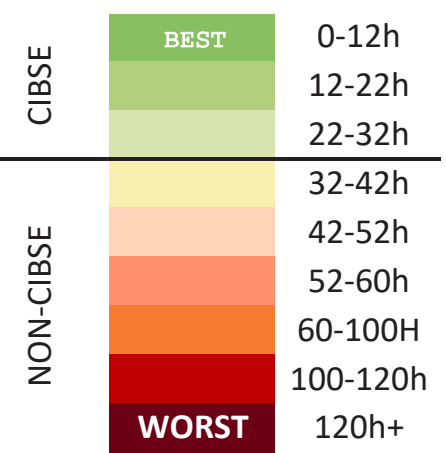
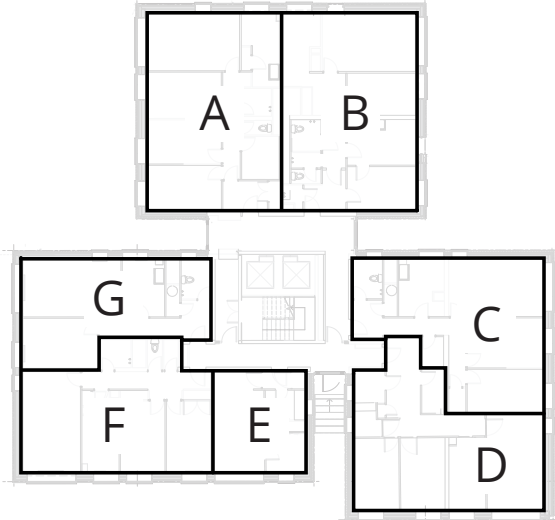

**Key**  
See Page 31 for explanation of what the hours represent.

ANALYSING THE OPAQUE VS. GLAZED LOWER PANEL

**OPAQUE VS GLAZED PANEL OVERHEATING RESULTS: CRITERION B 2041 - 2070**

**DO THE NEW WINDOWS MEET BUILDING REGULATIONS?**

Yes, both the glazed and spandrel panel windows meet regulations. The testing has been carried out to ensure the new windows perform better than the existing windows. The windows do not need to pass the CIBSE TM59 test as this is not a requirement under the Building Regulations.

**Both the new windows and the previous alternative with a spandrel panel perform better than the existing windows.**

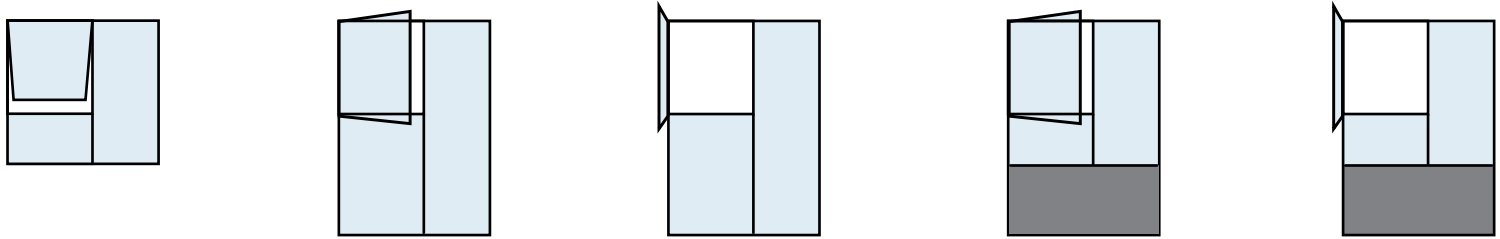

**WILL THIS SCENARIO DEFINITELY HAPPEN?**

These results predict how the windows perform during summer weather in 2041-2070, based on predicted future weather in which there has been high carbon emissions and a greater chance of extreme weather.

The science behind the 26° criteria is under review (see Page 31) and it is very common for bedrooms not to comply when tested against 2041-2070 weather data.

**HOW MUCH DIFFERENCE DOES THE SPANDREL MAKE?**

If this scenario occurs, the new windows provide improvements of roughly **45%** for rooms within the existing towers and greatly reduce the likelihood of overheating.

The spandrel panel performs slightly better than the glazed panel in the CIBSE TM59 test but the difference is not significant so residents were given a choice.

For more information refer to Page 30 and Page 55.

		Existing 30cm Tilt Out	New: GLAZED PANEL		Alternative: SPANDREL PANEL	
			30cm Turn In	90° Turn In	30cm Turn In	90° Turn In
Flat A	Bedroom	123	68	68	41	41
	Bedroom	124	67	67	41	41
	Bedroom	132	71	70	42	42
Flat B	Bedroom	100	59	59	38	38
	Bedroom	107	63	63	39	39
	Bedroom	117	68	66	42	42
Flat C	Bedroom	112	65	63	41	41
	Bedroom	110	64	60	38	38
Flat D	Bedroom	126	61	61	40	40
	Bedroom	125	70	70	41	41
Flat E	Studio	153	88	87	81	81
Flat F	Bedroom	126	68	68	41	41
	Bedroom	127	62	62	40	40
Flat G	Bedroom	127	70	66	44	43

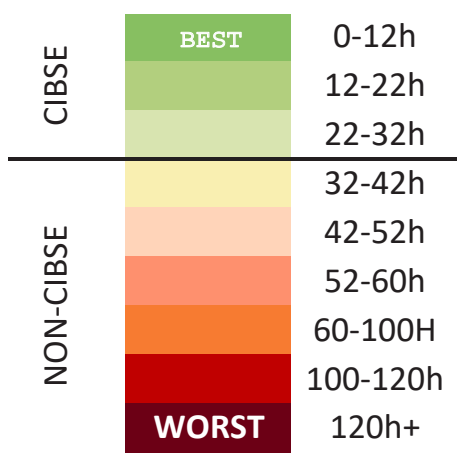
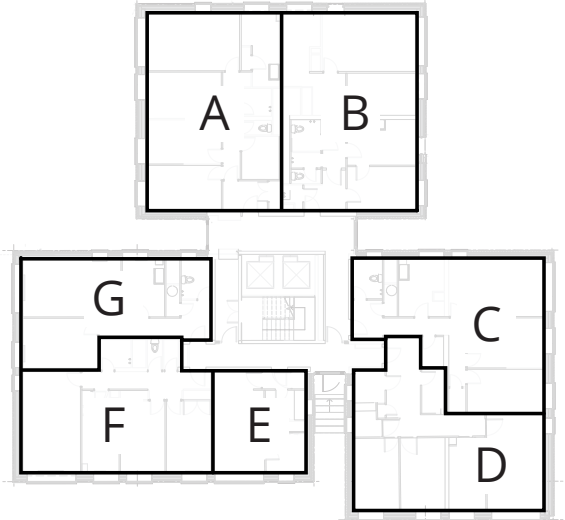

**Key**  
See Page 31 for explanation of what the hours represent.

# NEW WINDOWS

## WILL RAIN COME THROUGH OPEN WINDOWS?

There are no standards, tests or regulatory guidance about preventing rain from coming in through an open window.

**Any open window has the potential to let rain in under certain weather conditions.**

**It is advised to close windows before leaving a property.**

Windows have trickle vents which can be opened to allow a low level of ventilation even when windows are closed. See Page 26 for more information about trickle vents.

The following diagrams show how the new window positions may let in rain, compared to the existing windows.

Main lounge and bedroom window

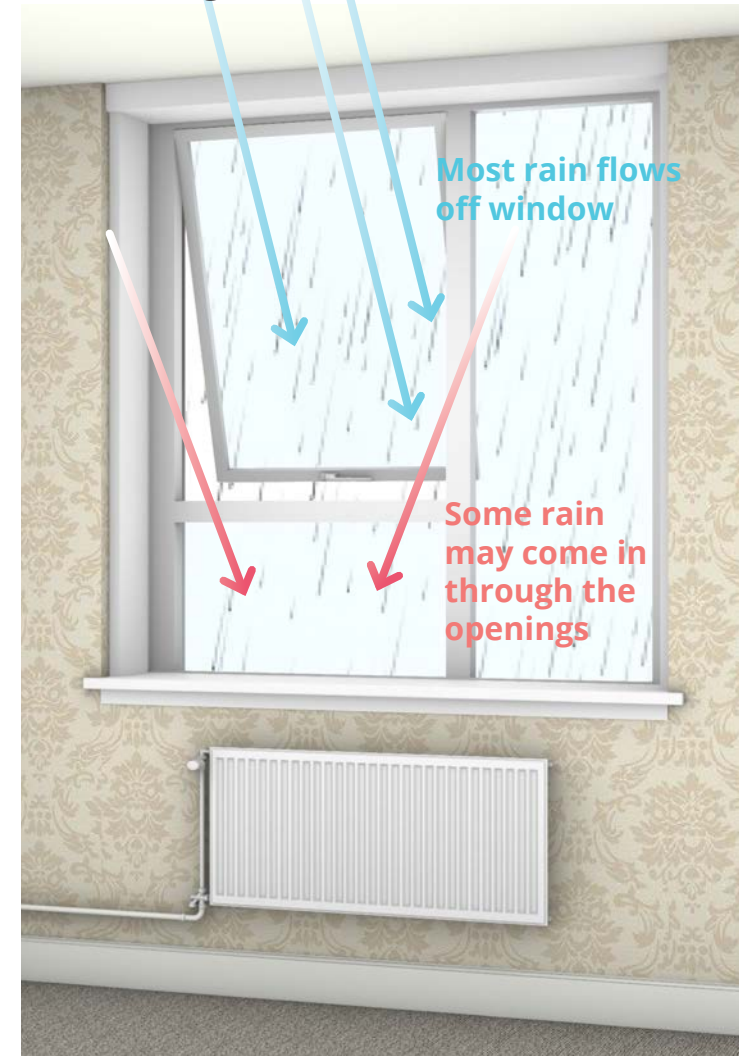

Existing window

Tilt-out is top-hung so most rain will flow off the window. However rain may come in through the open sides, especially in windy conditions.

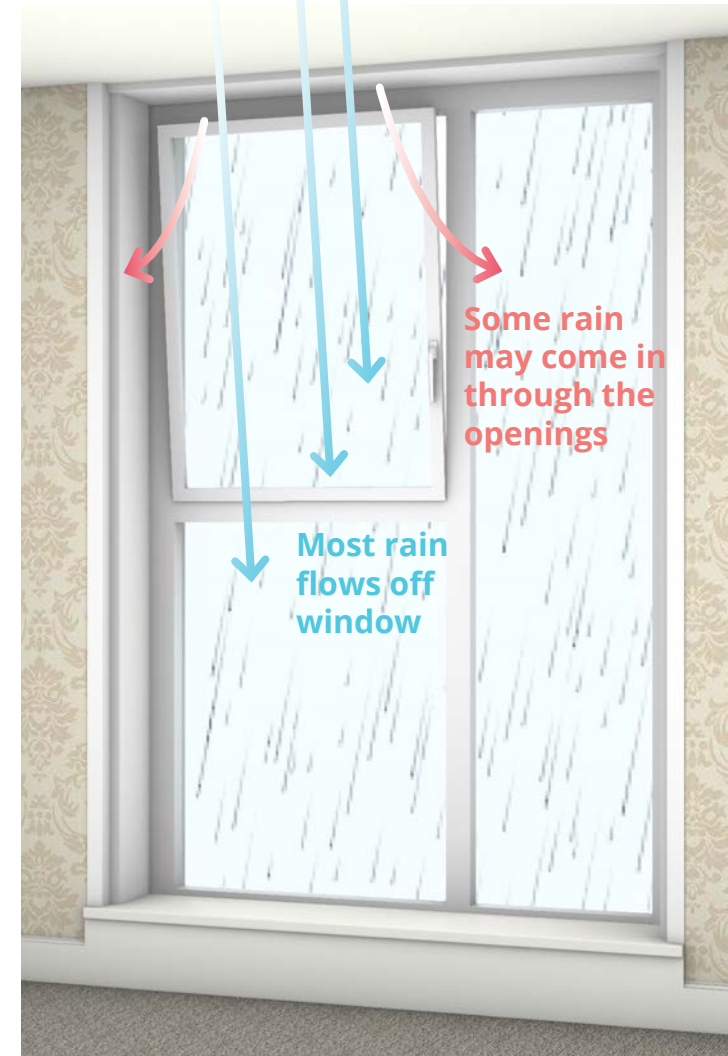

10cm Tilt

The tilt-in is bottom-hung so most rain will flow off the window. However rain may come in through the open sides, especially in windy conditions.



30cm Turn

The window opens further to allow for better ventilation, however this will also mean rain could come in through the opening, especially in windy conditions.

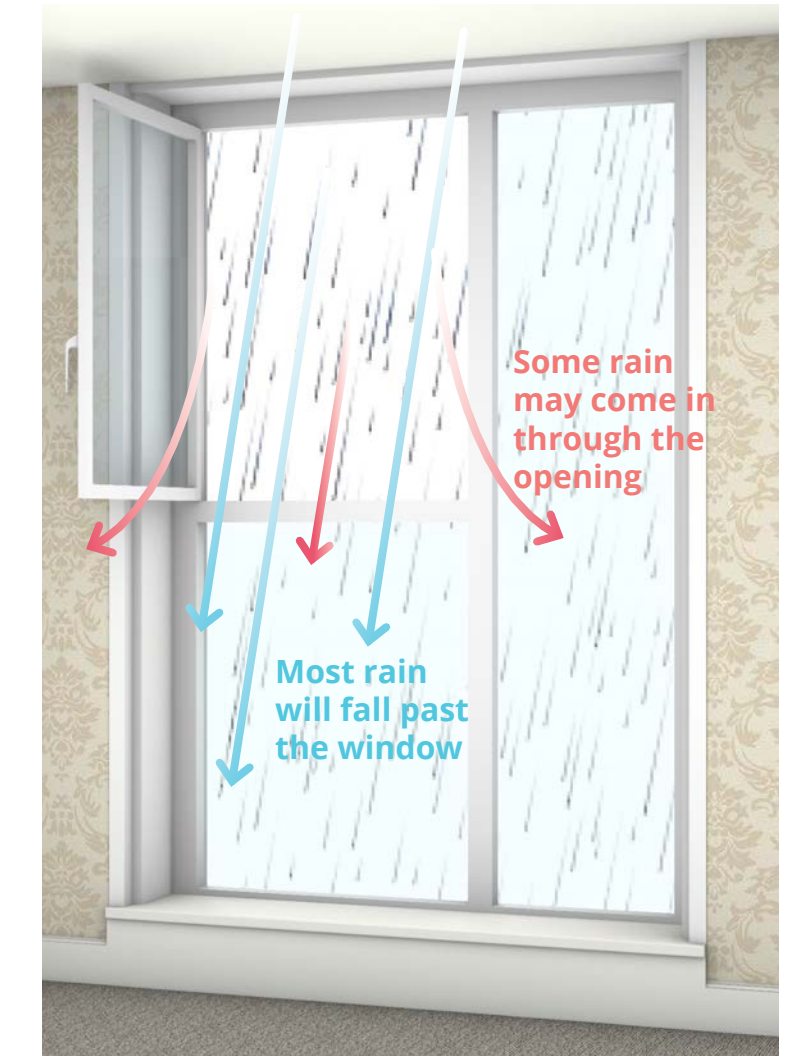

90° Turn

The window opens further to allow for purge ventilation, however this will also mean rain could come in through the opening, especially in windy conditions.

Kitchen, bathroom and side window to lounge

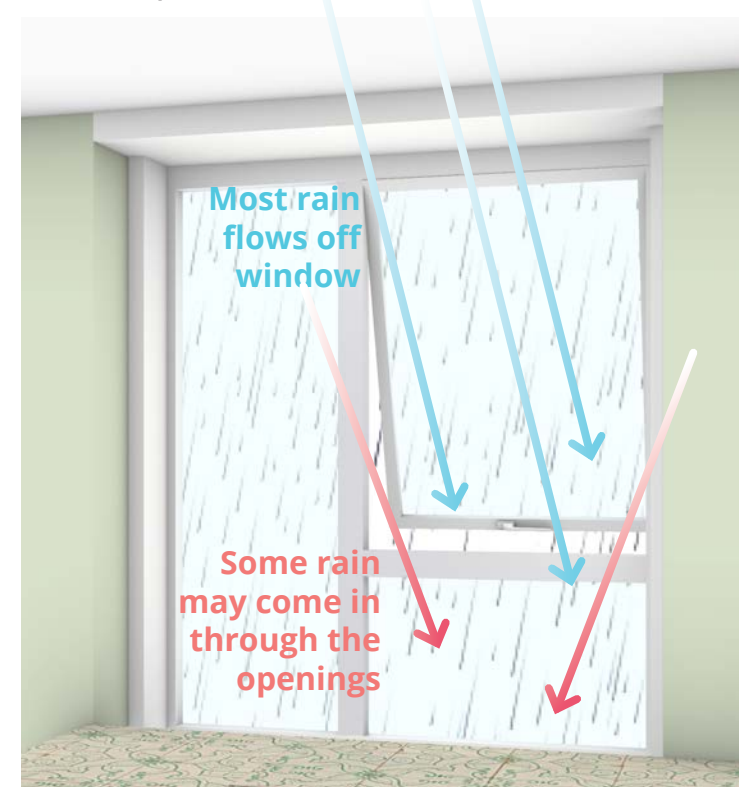

Existing window

Tilt-out is top-hung so most rain will flow off the window. However rain may come in through the open sides, especially in windy conditions.



10cm Tilt

The tilt-in is bottom-hung so most rain will flow off the window. However rain may come in through the open sides, especially in windy conditions.



40° Tilt

The tilt-in is bottom-hung so most rain will flow off the window. The window opens further to allow for purge ventilation, however rain may come in through the opening, especially in windy conditions.

# NEW WINDOWS

## THE ALUMINIUM REVEALS PROPOSAL

### WILL SKIRTING BOARDS BE CHANGED? CAN THEY BE DESIGNED TO COVER ANY DAMAGE TO THE CARPETS AND FLOOR FINISHES?

Yes, the skirting board in front of the window sills will be removed. In the proposal with aluminium reveals, we are looking at a prefabricated window sill which can slot into place to minimise time on site. In this case, the painted timber panel will replace the skirting board and protrude slightly further out to cover any damage to carpets and floor finishes. Note there would also be an aluminium sheet behind the timber panel for extra fire safety.

### INSTALLING BLINDS/CURTAINS WILL REQUIRE DRILLING THROUGH THE ALUMINIUM REVEALS. WILL THIS CAUSE ANY RISK OF FIRE SPREAD OR NOISE?

No, the fire stops and cavity barriers will not be affected.

### WILL THE ALUMINIUM REVEALS GET HOT IF THE SUN SHINES ON THEM?

The reveals will heat up quicker, but not to levels that would pose a risk. They would also cool down quicker when the sun goes away. The finishes are of a light colour which reduces heat absorption. Note that the window sill will have a timber finish, only the reveals will have the aluminium finish.

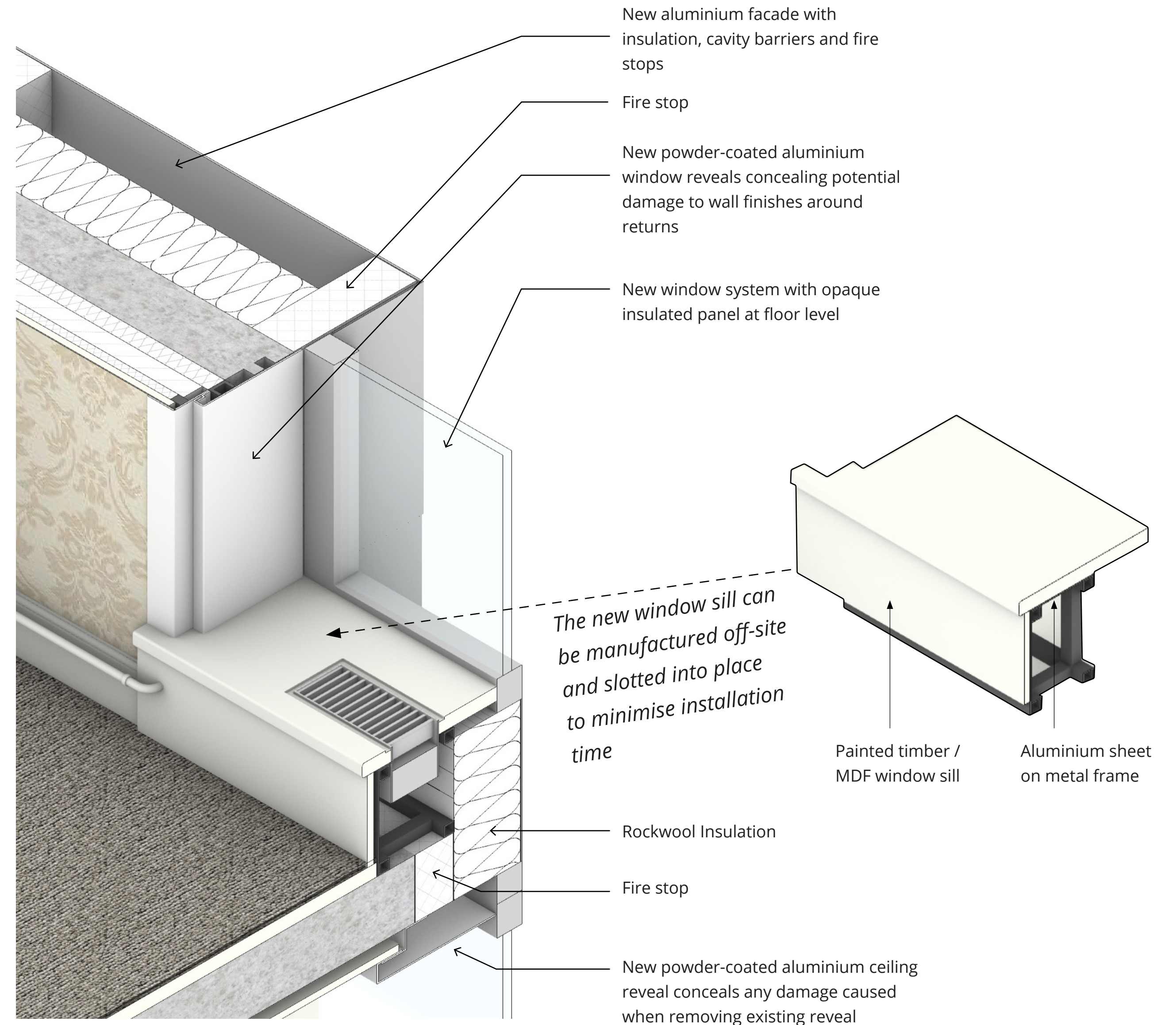

*Illustrative proposal showing aluminium reveals and trench heater system to reduce damage to interior finishes and reduce time spent inside the residents' flat for installation. Trench heater is optional - see Page 48.*

## A CLOSER LOOK AT: CONDENSATION

The design of the external window reveals (the 'jamb') have been verified against the risk of surface condensation and mould growth.

For the analysis, we used the internal and external temperatures and humidity as set out by the project façade specification and the method described in the British Standard EN ISO 13788.

The temperatures used for this test are: internal temperature of 20°C, external temperature -5°C, and 55% relative humidity.

Under these assumptions, we concluded that this interface is not at risk of surface condensation and mould growth.

The external parts of the façade, including firestops and insulation, provide adequate insulation to mitigate the risk of condensation and/or mould growth.

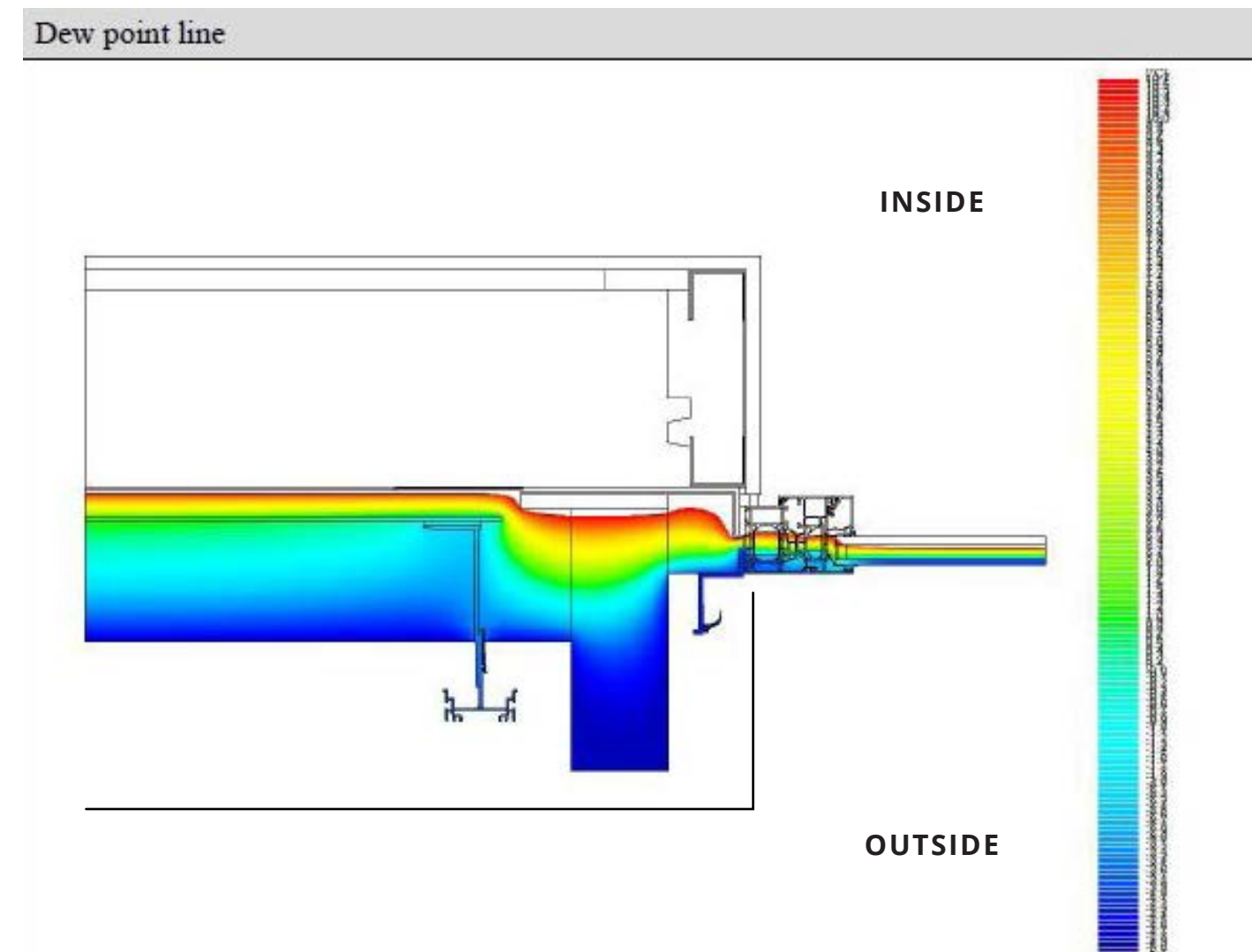

*Extract from Arup's Stage 4 Surface Condensation Thermal Analysis*

In the diagram above we can see that the dew point (the red line) does not touch the internal surface of the wall, therefore the window and reveal is not considered at risk.

### WOULD ALUMINIUM WINDOW REVEALS CAUSE CONDENSATION?

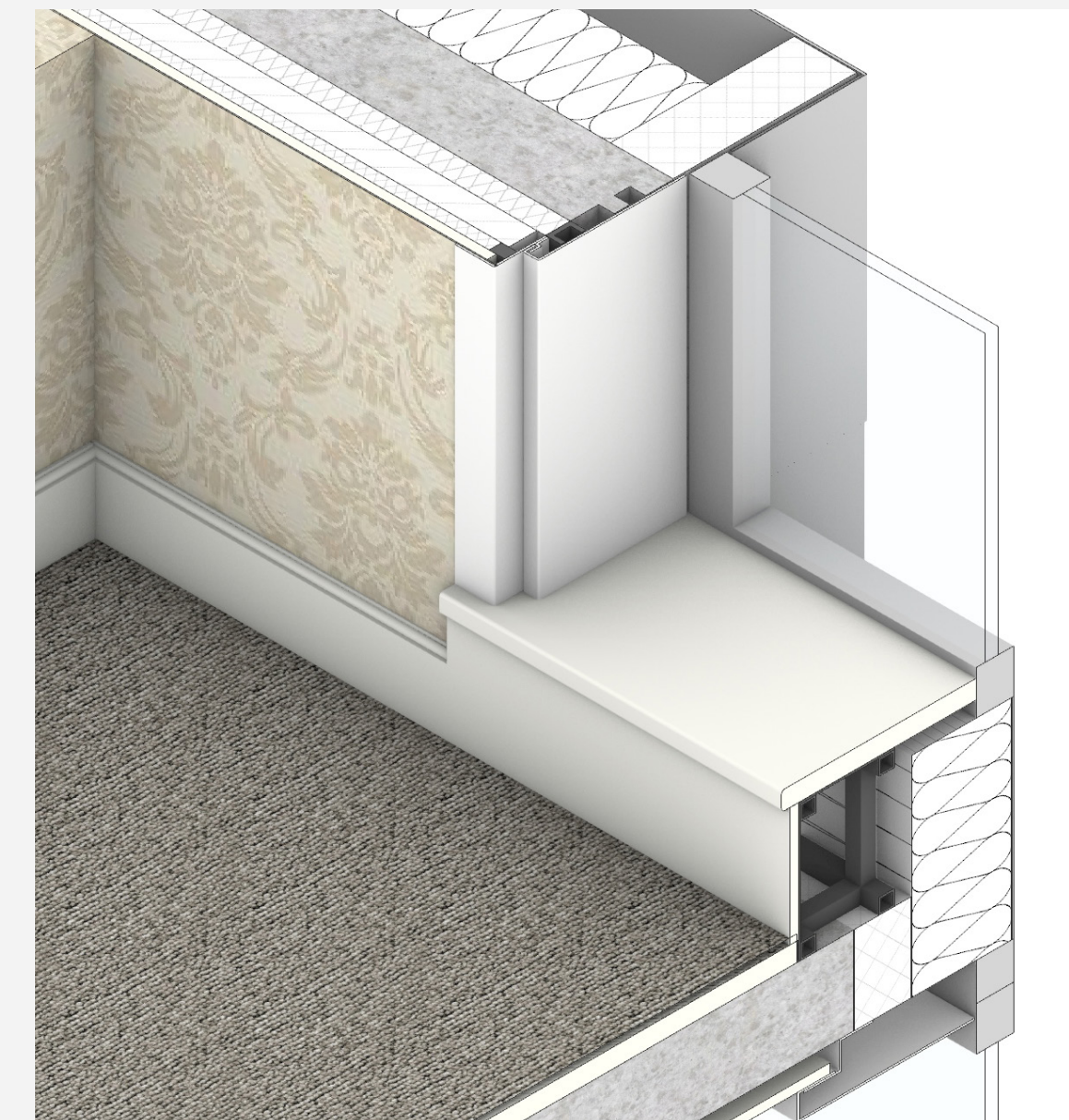
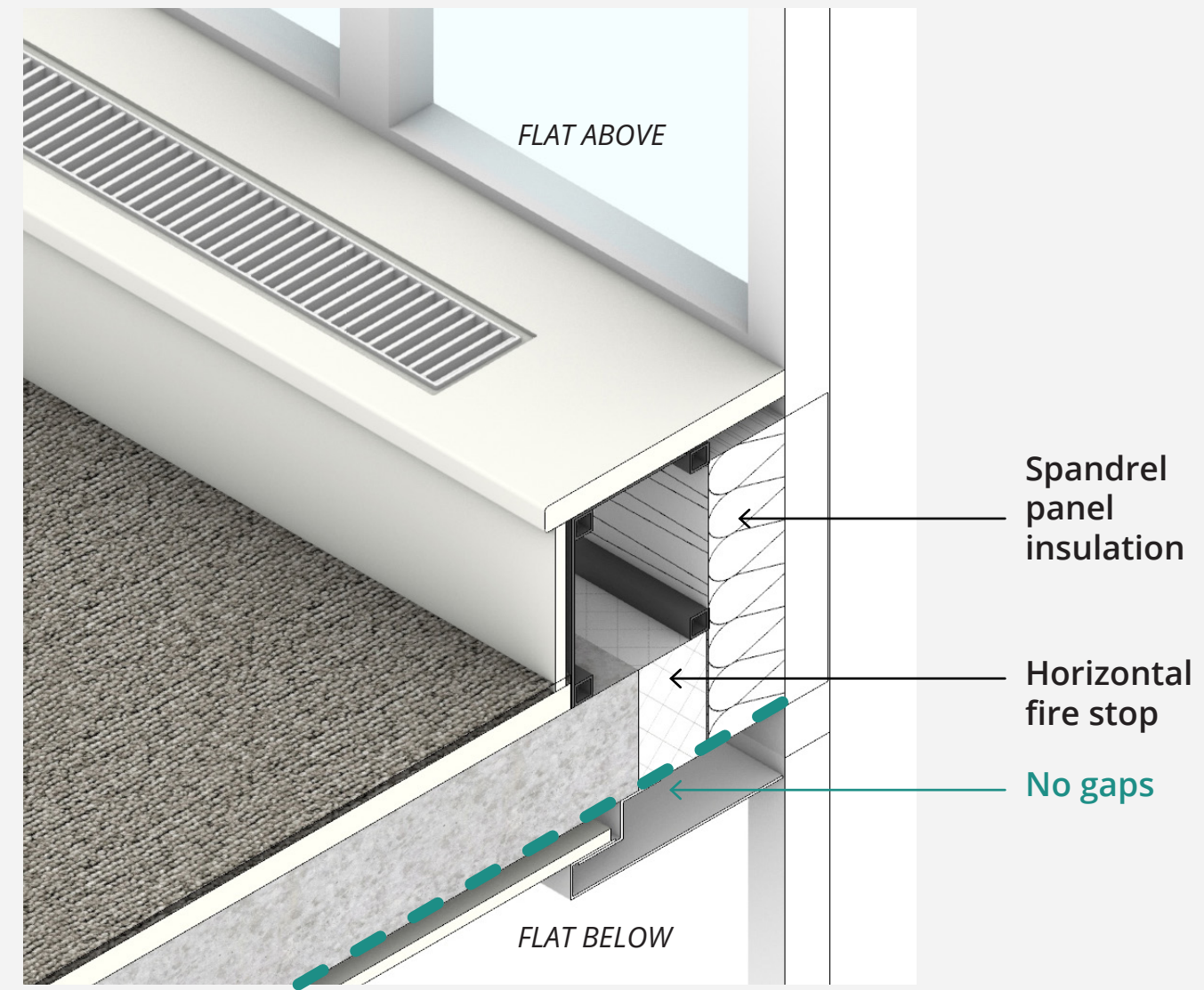

*Illustration of a window with aluminium reveals*

The material of the reveals will not affect the condensation calculation described on this page.

## A CLOSER LOOK AT: WINDOW SILLS

### FIRE STOPPING & CAVITY BARRIERS: STOPPING THE SPREAD OF FIRE, SMOKE & NOISE



*Illustrative diagram showing the insulation and fire stop behind a window sill. Trench heater is optional - see Page 48.*

There are no gaps between floors and the fire stop as well as the spandrel insulation provide sound proofing. The fire stops prevent the spread of fire and smoke.

The diagram above shows the fire stop and the insulation between the concrete floor slab and the window. These block any gaps between the building levels.

11

## FURTHER QUESTIONS & ANSWERS



## NEW WINDOWS

### **Are the new windows sturdy enough to take strong forces, such as high wind or someone leaning on them?**

Yes, the new windows will be designed to take barrier loads. They are subject to the same minimum standards as a balustrade.

### **Is the new glazing more reflective and will it create a glare for surrounding residents?**

The new glazing lets less of the sun's heat through (see G-Value, Page 28) however this does not mean it is more reflective.

It is unlikely that there will be a noticeable difference in terms of reflectivity compared to the current windows.

### **Will the new windows be too heavy to open and close?**

This issue has been considered, and there will be a close-assist mechanism for kitchen windows at the 40° opening setting which are more likely to require assistance for some residents.

### **What regulations do the new windows have to meet?**

This question is addressed on Page 16.

### **How did we decide to make the new lower panel glazed?**

This question is addressed on Page 55.

### **Will rain come through the new windows if left open?**

This question is addressed on Page 60.

## WINDOW OPERATION

### **I don't want my window to open 90°**

Windows can be locked so they don't open 90°. Please refer to Pages 13 & 14 for opening settings of the new windows.

### **Can we add another setting to the tilt-only windows between 10cm and 40°?**

The original intention was to have 3 settings, however the manufacturer has advised that it is not technically possible to incorporate this into the frame.

### **Can the tilt-only window in the kitchen be restricted to 35cm instead of 40°?**

This would not provide adequate ventilation. The window must open more than 30° to provide the minimum ventilation standards. 35cm is approximately 20° so would not meet the regulations for purge ventilation. For more information on purge ventilation calculations, see Pages 24 & 25.

### **Can the tilt-and-turn windows open to the exact measurement of the window sill, instead of 30cm?**

As the window sill depth varies across The Chalcots Estate (~25 - 40 cm) this would be difficult to achieve. We need a consistent measurement for the manufacturer.

### **The existing kitchen window in Blashford is too heavy to open and they are too wide to reach the restrictor release, even with both arms stretched out. Can the window be split in two?**

Yes, the large windows in Blashford are going to be split in two, with one side openable and the other fixed. This is shown in the planning application.

## SAFETY

### **Are the 90° windows too risky?**

There is a risk of overheating if better ventilation is not provided. Therefore we believe the best option is to provide better ventilation, but increase the safety measures. The measures we have taken are:

1. Windows open inwards so residents don't have to lean out of the windows to open/close the windows (Page 22)
2. The window sill has been lowered to reduce the risk of falls (Pages 20 & 21)
3. The window opening is controlled through safety features that would need to be disengaged through special keys. The window opening options are designed to meet the requirements for most residents and the choice of using the 90° opening is a personal one.

See Page 13 for how to lock your window so it doesn't open 90°.

### **Why can't the windows open outwards to save space in the rooms and reduce the risk of banging your head?**

In order to provide better ventilation but maintain safety standards, the new windows open inwards. The risk of windows opening outwards more than 30cm on high-rise residential buildings is deemed to carry too much risk.

See Page 22 to understand these risks. See Page 13 for how to lock your window so it doesn't open 90°.

### **Why do the existing windows need replacing?**

This question is addressed on Page 19.

### **What safety standards do the new windows need to meet?**

This question is addressed on Page 19, 22, and 16.

### **Why are the new window sills lowered in lounges and bedrooms?**

This question is addressed on Page 20.

## VENTILATION

### **Do the inward-opening windows mean less air and wind will get into the room, reducing the effect of ventilation?**

No, this is not correct. Air flow is included in the overheating calculations. Page 33 has more information about how air flow is calculated, including diagrams showing how the window reveals are taken into account. Page 24 shows how purge ventilation is calculated.

### **How is the purge ventilation calculated?**

This question is addressed on Page 24.

### **Do the new windows meet current purge ventilation standards?**

This question is addressed on Page 25.

## OVERHEATING

### **How can larger windows not generate more overheating?**

The new glass specification and improved ventilation mean the new windows perform significantly better than the existing ones. Please refer to Page 28.

### **Does the overheating analysis take into account furniture and occupational uses?**

It does not take into account furniture as this is not relevant for the calculations but it does consider heat generated by people, appliances and lighting. Please see Page 29 for all the key considerations taken into account when calculating the overheating.

### **Can the disused vents in kitchens be used as extra ventilation for the top floor flats?**

This is currently not part of the envelope refurbishment as the Major Works already improve the ventilation and reduce overheating for all flats. For more on these improvements, see Chapter 5: Ventilation and Chapter 6: Overheating.

### **How have the overheating and energy conservation improvements been achieved?**

This question is addressed on Page 28.

### **Why did we use the CIBSE TM59 method to calculate overheating on Chalcots?**

This question is addressed on Page 30.

### **Does the overheating calculation take into account climate change?**

This question is addressed on Page 30.

### **Is the overheating calculation method future proof?**

This question is addressed on Page 30.

### **Is the overheating analysis carried out on a virtual model?**

This question is addressed on Page 32.

### **Are the window reveals taken into account for the overheating calculation?**

This question is addressed on Page 33.

## ADDITIONAL CONSIDERATIONS

### **What can be done about vertigo and privacy concerns?**

A film can be applied to cover the glazed panels. See Page 41.

### **Will there be a night latch to lock windows like the existing windows?**

No, unfortunately the proposed manufacturers do not offer this option. Instead all windows have a 10cm tilt position which can function as background ventilation. Trickle vents can also be used for background ventilation.

## QUESTIONS & ANSWERS

### **Will there be an option to make opening the windows more accessible?**

This question is addressed on Page 40

### **Have you considered views into bathrooms?**

This question is addressed on Page 42.

## **RADIATORS**

### **Will the sound of the trench heater reverberate off the aluminium reveals?**

Please refer to Pages 49 'Are the trench heaters noisy?'. Reverberation is not deemed to be an issue. A trench heater will be installed in the show flat for residents to see before they make the decision on the radiator option in their home.

### **Why isn't a larger radiator under the side window enough to heat the entire room?**

The size of the radiator that fits under this window would not generate enough heat output. Furthermore, radiators are best placed near the biggest windows in the room, otherwise they are less effective.

### **Do trench heaters have an isolation valve?**

Yes, trench heaters have an isolation 'shut-off' valve. An example of a trench heater that could be installed is the Kampmann Katherm QK 190. For more information about trench heaters see Pages 49-53.

### **How will the fan of the trench heater be connected?**

The fan is an integral part of the radiator and will be hard-wired into the in-home power circuit. See diagram on page 52.

### **What are the options for the new radiators?**

This question is addressed on Page 48.

### **Can I have the trench heater on at night when the curtains are closed?**

This question is addressed on Page 49.

### **Are the trench heaters noisy?**

This question is addressed on Page 49.

### **Is it easy to maintain the trench heater?**

This question is addressed on Page 50.

### **What if I drop something in the trench heater?**

This question is addressed on Page 50.

### **What if someone leaves paper on the trench heater - is there a fire risk?**

This question is addressed on Page 50.

### **Can the trench heater be turned to face inwards?**

This question is addressed on Page 51.

### **Will there be space for plants or storage on my window sill?**

This question is addressed on Page 51.

### **Is there a risk of a child burning their feet by standing on the grille of the trench heater?**

This question is addressed on Page 52.

### **Are trench heaters expensive to run?**

This question is addressed on Page 52.

### **Will the trench heaters work with the existing radiators?**

This question is addressed on Page 52.

### **Are there examples of trench heaters used in residential settings?**

This question is addressed on Page 53.

### **Can the window sill slope downwards into the room to prevent damage from standing on the sill?**

This question is addressed on Page 53.

### ITEMS RELATED TO THE NEW WINDOWS

#### **How will the wall under the window sill be insulated?**

The spandrel panel has rock wool insulation, and there is a fire stop under the sill. See diagram Page 63.

#### **Can noise travel through the window sills to the flat above/below**

All gaps between floor levels are filled in with fire stops / rock wool insulation to prevent noise traveling. See diagram Page 63.

#### **Where is the fire stopping?**

The fire stops are installed between floor levels. See diagram Page 63.

#### **Can smoke travel through from the flat below?**

All gaps between floor levels are filled in with fire stops or rock wool insulation. See diagram Page 63.

#### **Will the aluminium reveals get hot if the sun shines on them?**

This question is addressed on Page 61.

#### **Have the new aluminium window reveal designs taken into account condensation and mould?**

This question is addressed on Page 62.

#### **Will skirting boards be changed when the new window sills are installed?**

This question is addressed on Page 61.

#### **Can the new window sills be designed to cover any damage to the carpets and floor finishes?**

This question is addressed on Page 61.

#### **Installing blinds/curtains will require drilling through the aluminium reveals. Will this cause any risk of fire spread or noise?**

This question is addressed on Page 61.

